



Keo
Stue



Levende konsepter

Living concepts

**Hva gjør et rom til et hjem? Menneskene som bor der, selvfølgelig. Pluss slik de er møblert. Fra den minste detalj til den konsistente utformingen av individuelle rom - vi har vært markedsledende innen kjøkkensegmentet, og utvikling av høykvalitetsmøbler som oppfyller kravene til stor individuell planlegging i flere tiår. For oss, gir dette den ideelle forutsetningen for å demonstrere vår planleggingskompetanse og høye standarder av kvalitet og brukervennlighet. inkludert da også på bad og oppholdsrom. Og vi gjør det med stor suksess!
Resultatet: Vi kombinerer kjøkken, stue og spisestue til ett boareal på en helhetlig måte. For ditt individuelle hjem!**

What turns rooms into a home? The people who live there, of course. Plus the way they furnish them. From the smallest detail to the consistent design of the individual rooms – as a market leader in the fitted kitchen sector, we have been developing high-quality system furniture that meets high individual planning standards for decades. For us, this is the ideal prerequisite for demonstrating our planning expertise and our high standards of quality and usability, including in bathroom and living areas. And we do it with great success! The result: we combine kitchen, living and dining into one living space in a holistic way. For your individual home!

4 **Opplev ditt hus** Experience your home

12 **Livsmiljø** Living environments

78 **Planleggingsforslag** Planning suggestions

95 **Dekor og håndtak** Décor and handles



Opplev ditt hjem Experience your home

For familier er dagen alltid full av bevegelse, også hjemme. Ikke bare leker barn her, men det er her livet skjer. Så det kan bare være en god ting hvis møblene er laget for nøyaktig dette og kan takle alt som blir kastet på det dag og natt. Velkommen hjem!

For families, the day is always full of movement, even at home. Not only do children play here, but this is where life plays out. So it can only be a good thing if the furniture is made for exactly this and can cope with everything that's thrown at it day and night. Welcome home!



Experience your home

6-7

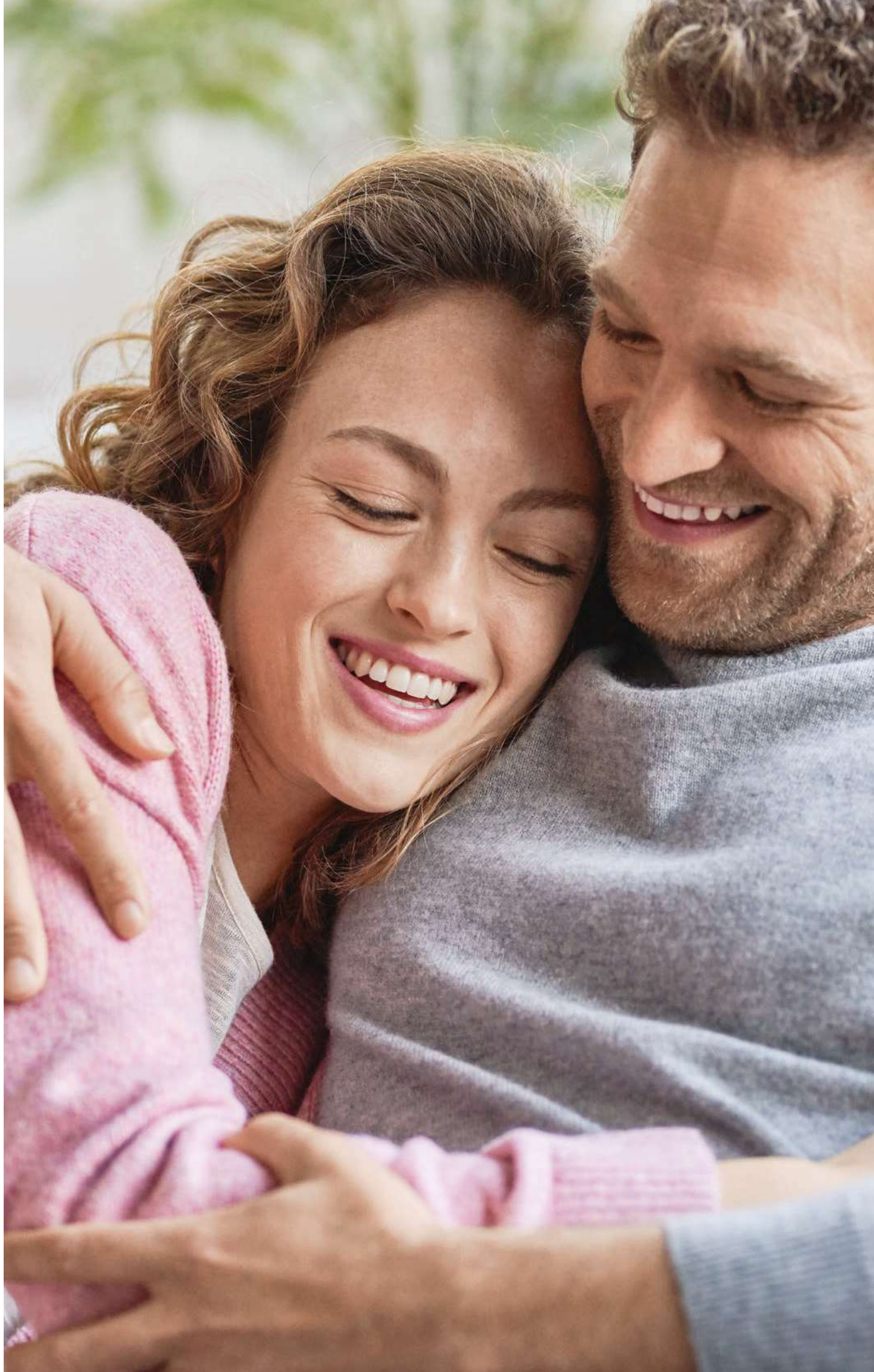



8-9

Experience your home



**Gjør om garderoben til
en klesdrøm**

TURN YOUR DRESSING ROOM
INTO A CLOTHING DREAM.





God morgen!

HELLO!

Gjør deg klar for jobb, pakker skolesekken, ta av og på jakkene . Kom hjem og si velkommen til gjester. Det er alltid noe som skjer her.

—
Get ready for work, pack the school satchel, pull your jackets on and off you go. Come home and welcome guests. There's always something going on here.



**EN SANN KJÆRLIGHET FOR ORDEN -
MED DEN RETTE GARDEROBEN**

A TRUE LOVE OF ORDER -
WITH THE RIGHT WARDROBE.

10-11

**NÅR FAMILIEFROKOST
BLIR ET ØYEBLIKK AV GLEDE**

WHEN THE FAMILY BREAKFAST
BECOMES A MOMENT TO ENJOY.



Experience your home

NÅR Å LEVE BLIR EN FØLELSE AV VELVÆRE

WHEN LIVING BECOMES A FEELING OF WELL-BEING.



KOM SAMMEN

GET TOGETHER

Frokost med familien, en kveld hvor man spiller spill sammen, matlaging med venner eller gankse enkelt salpe av på sofaen: Det er rom for alt.

Breakfast with the family, an evening playing games together, cooking with friends or simply relaxing on the sofa: there's space for everything here.



54
Øyeblikk
av
fornøyelse



54
Genussmoment
Moments of
enjoyment



64
Ordnungs-
liebe
A love
of order

64
kjærlighet
for
orden



14 Levende atmosfære

14 Wohngefühl Living atmosphere



Levende miljø

Living environments

Induvalitet har mange ansikter. dette er derfor våre møbler også tilbyr uendelige muligheter for design av individuelle rom, komplette miljøer eller modifisering av dem. Få inspirasjon!

Individuality has many faces. This is why our furnishing elements also offer unlimited possibilities for designing individual rooms or complete living environments as well as modifying them. Get some inspiration!

72 Kles- drømmer

72 Kleider- traum Clothing dreams





Levende atmosfære

Living atmosphere

**Design ditt liv etter dine egne ideer.
våre intelligente og høykvalitetsmøbler
tilbyr mye frihet når det kommer til
materialer, farger og dimensjoner.**

Design your life according to your own ideas.
Our intelligent and high-quality system fur-
niture offers lots of freedom when it comes
to materials, colours and dimensions.





TOUCH

332 Lakklaminat, alpine hvit supermatt

332 Lacquered laminate, alpine white supermatt





LAGET ENKELT MADE EASY

Lys eik Sierra matt pluss hvit fronter former eb spesiell følelse av letthet. hyllene tilbyr ideelle plass for individuelle dekorative gjenstander.

Light oak Sierra plus matt white fronts subtly create a special feeling of lightness. The shelves offer the ideal platform for individual decorative items.



TOUCH

341 Lakkaminat, stein grå supermatt

341 Lacquered laminate, stone grey supermatt

TOUCH

334 Lakkaminat, skifer grå supermatt

334 Lacquered laminate, slate grey supermatt



KLART DESIGN

CLEAR DESIGN

Samspeilet mellom klare linjer og supermatte overflater i koordinerte grånyanser skaper en elegant og godt samtidsinntrykk.

The interplay of clear lines and super matt surfaces in coordinated grey shades creates an elegant and very contemporary impression.





NATURLIG KOMBINASJON

NATURALLY COMBINED

Kombinasjonen av materialer i form av varm Havana eik og alpine hvite overflater skaper en spennende, men hjemmekoselig atmosfære. Nydelig blikkfang: et uformelt design som av opplyste veggmonterte hyller.

The combination of materials in the form of warm Havana oak and alpine white surfaces creates an exciting but homely atmosphere. Lovely eye-catcher: a casual design that is emphasised by illuminated wall-mounted shelves.



FASHION

168 Lakk, alpine hvit matt

168 Lacquer, honed alpine white

STRUCTURA

402 Havana eik etterlikning

402 Havana oak reproduction



22-23



Living atmosphere

STATEMENT STATEMENT

Et sterkt utseende for en veldig moderne atmosfære. "kunsten og leve" er presentert i svart Nero eik med uttrekk i ultra-matt rustrød. Utrolig praktisk: belegg mot fingeravtrykk.

A strong appearance for a very contemporary ambience. The art of living is presented in black Nero oak with pull-outs in ultra-matt rust red. Amazingly practical: anti-fingerprint coating.



STRUCTURA

403 Nero eik etterlikning

403 Nero oak reproduction

EASYTOUCH

963 lakklaminat, rustrødt ultra matt

963 Lacquered laminate, rust red ultra matt



24-25

Living atmosphere



AVSLAPPET NATURLIG RELAXED NATURALNESS

Hvil, slapp av og lad opp batteriene. Hva bedre sted å gjøre dette enn i et koselig hjem med enkel innredning, varme kilder til lys, mye tre og et dempet fargevalg? Møblene er laget av lyst tre ser spesielt moderne ut i kombinasjon med betongvegger eller steingulv.

Rest, relax and recharge your batteries. What better place to do this than in a cosy home with simple furnishing elements, warm sources of light, lots of wood and a muted colour scheme? The furniture made from light wood looks especially contemporary in combination with concrete walls or stone floors.





TOUCH

341 Lakkaminat, steingrå supermatt

341 Lacquered laminate, stone grey supermatt



AVSLAPPET

RELAXED

De luftige hylle elementene i lys Eik Sanremo lager en moderne åpen "feel-good" atmosfære og gir en plass for ditt favoritt tilbehør.

The airy shelving element in light oak Sanremo creates a modern and open feel-good ambience and offers space for showcasing your favourite accessories.





TIDLØS MODERNE

TIMELESSLY MODERN

Veggelement i håndløst design ser eksepsjonelt moderne og elegant ut. kombinert med fine tresorter, skaper dette et tidløst utseende som beriker ethvert rom.

The handleless design of the wall elements looks exceptionally modern and elegant. Combined with fine woods, this creates a timeless look that enriches any room.



TOUCH

334 Lakklaminat, skifetgrå supermatt

334 Lacquered laminate, slate grey supermatt



30-31



Living atmosphere





TOUCH

340 Lakklaminat, sort supermatt

340 Lacquered laminate, black supermatt



STRUCTURA

402 Havana eik etterlikning

402 Havana oak reproduction

AUFGESCHOBEN MOVED

Skyvedører som designelement skaper lagringsplass og gir møblene i naturlig Havanna eik en kul touch.

Sliding doors as a design element create storage space and give the furniture in natural Havanna look oak a cool touch.



EASYTOUCH

963 Lakkaminat, Rustrødt ultra matt

963 Lacquered laminate, rust red ultra matt



RIVA

889 Betong skifergrå etterlikning

889 Concrete Slate Grey reproduction



STERKT UTSEENDE

STRONG LOOKS

**Et individuelt ensemble med wow-faktoren.
Bakveggen i en betong
look skaper det perfekte bakteppet for
kontrasterende skap i rust
rød med ultra matt anti-fingeravtrykk overflater.**

An individual ensemble with the wow factor. The rear wall in a concrete look creates the perfect backdrop for contrasting cupboards in rust red with ultra matt anti-fingerprint surfaces.



INLINE

551 Lakk, Alpine hvit matt

551 Lacquer, honed alpine white

KANSAS

597 Sierra eik etterlikning

597 Sierra oak reproduction



BLIKKFANGER

EYE-CATCHER

To eksklusive serier gir et absolutt høydepunkt. Firkantede skap i moderne tradisjonell stil ser imponerende ut med sine individuelt utformede innrammede dører. Uttrekkbare elementet i elegant matt lakk ser spesielt smart ut takket være de integrerte innfelte håndtakene.

Two exclusive ranges give rise to an absolute highlight. The square cupboards in modern country house look impress with their individually crafted framed doors. The pull-out element in elegant matt lacquer looks particularly smart thanks to the integrated recessed handles.



36-37

Living atmosphere



URBAN HYGGE

URBAN COSINESS

En stil som ser både urban og hjemmekoselig ut på samme tid, og på en avslappet måte. Naturmaterialer og grå nyanser samt dekorative grønne planter skaper ideelt miljø for et veldig moderne møbelmiljø i tre av høy kvalitet avslutt med overflater som minner om landstilen.

A style that looks both urban and homely at the same time, and in a relaxed way. Natural materials and grey nuances as well as decorative green plants create the ideal environment for a very contemporary furniture system in a high quality wood finish with surfaces that are reminiscent of the country house style.



GENT

741 Lakkaminat, steingrå

741 Lacquered laminate, stone grey

STRUCTURA

402 Havanna eik etterlikning

402 Havana oak reproduction



OVERRASKENDE DETALJER

SURPRISING DETAILS

Dobbelt vakker - og praktisk. Variabelen Smartcubebehyller, individuelle dekorative ideer og de puristiske skapelementene. tilbyr ikke bare lagringsplass, men imponer også med praktiske stangklaffer. Og i tillegg er den subtile innredningen et blikkfang i Gent-frontene med fin rillestruktur.

Doubly beautiful – and practical. The variable Smartcube shelves showcase individual decorative ideas and the puristic cupboard elements not only offer storage space, but also impress with practical bar flaps. An additional eye-catcher is the subtle décor of the Gent fronts with fine groove structure.





MARMOR STIL

MARBLE STYLE

Kul kombinasjon! Teramo marmor reproduksjon gir de hengende enhetene med nedfelte fronter deres rene og individuelle utseende. Dette passer med forskjellige levende stiler.

Cool combination! The Teramo marble reproduction gives the suspended units with fold down fronts their pure and individual touch. This fits with different living styles.



COLOR CONCEPT

274 Marmor teramo etterlikning

274 Teramo marble reproduction

TOUCH

338 Lakklaminat, satin grå supermatt

338 Lacquered laminate, satin grey supermatt





VAKKERT KOMPAKT WONDERFULLY COMPACT

En spennende blanding av dybder blir et ekte blikkfang og viser seg å være spesielt praktisk: utstikkende uttrekk gir et sjenerøst lagringsområde og mer lagring rom.

—
An exciting mix of depths becomes a real eye-catcher and proves to be particularly practical: the protruding pull-outs provide a generous storage area and more storage space.



STRUCTURA

405 Sierra eik etterlikning

405 Sierra oak reproduction

LUX

819 Lakk, grå høyglans

819 Lacquer, satin grey high gloss



44-45

Living atmosphere



SKJØNNET I KONTRASTER CONTRASTING BEAUTY

Sterke kontraster i svart og hvitt ser klassisk ut, høy kvalitet og tidløs. Sammen med et grafisk formspråk og individuelt tilbehør til et hjem som representeres med sin personlighet og som effektivt viser frem møblene som passer elementene i skifergrå.

Strong contrasts in black and white look classic, high quality and timeless. Coupled with a graphical design language and individual accessories for a home that impresses with its personality and that effectively showcases the furnishings which match the elements in slate grey.



46-47



GLASSKLART CRYSTAL CLEAR

Lys møter mørkt, og skaper en klar, urban estetisk. Glass som designelement bringer ekstra lys i spillet.

Light meets dark, creating a clear, urban aesthetic. Glass as a design element brings additional light into play.

Living atmosphere





TOUCH

334 Lakklaminat skifergrå supermatt

334 Lacquered laminate, slate grey supermatt

TOUCH

332 Lakklaminat alpine hvit supermatt

332 Lacquered laminate, alpine white supermatt

48-49

Living atmosphere



RIVA

892 Betonggrå etterlikning

892 Concrete grey reproduction

EASYTOUCH

961 Lakklaminat grafit sort ultra matt

961 Lacquered laminate, graphite black ultra matt





GRÅ SKALA

GREYSCALE

Puristiske uttrekk i et betongutseende og grafitsorte elementer med en praktisk anti-fingeravtrykkbelegg blir brakt sammen av bakveggen, og danner et harmonisk trekk. En sterk kombinasjon som ser begge deler ut kult og elegant.

Puristic pull-outs in a concrete look and graphite black elements with a practical anti-fingerprint coating are brought together by the rear wall, forming a harmonious feature. A strong combination that looks both cool and elegant.

LUX

823 Lakk, skifergrå høyglans

823 Lacquer, slate grey high gloss

STRUCTURA

402 Havanna eik etterlikning

402 Havana oak reproduction





SETTE STIL

SETTING ACCENTS

Veggssystemet i skifergrå høyglans inspirerer med sitt design og praktiske uttrekk. Med vakkert kontrastelementer laget av Havanna eik.

The wall system in slate-grey high gloss inspires with its design and practical pull-outs. Beautiful contrasting elements made from Havanna oak.

SPILLEROM

FREEDOM TO PLAY

Moderne lagringsdesign kan se så allsidig ut. Blikkfang: det integrerte konsollpanelet i et strukturert Sierra eik utseende gir et sterkt uttrykk som et designelement.

—
Modern storage design can look this versatile.
Eye-catcher: the integrated console panel in a structured Sierra oak look makes a strong statement as a design element.





FASHION

173 Lakk hvit matt

173 Lacquer, honed white



Øyeblikk av hygge

Moments of enjoyment

Kos deg med maten din hvor og hvordan du vil. Når matlaging, spise og leve, smelter sømløst sammen gir møblene våre de ideelle koblingene mellom dem.

Enjoy your food how and wherever you want. When cooking, eating and living merge seamlessly into one another, our furniture provides the ideal links between them.





STRUCTURA

405 Sierra eik etterlikning

405 Sierra oak reproduction

LETTHET LIGHTNESS

Godt planlagt glede! Et spisestue der alt passer perfekt sammen takket være et klart designspråk og en eksklusiv design overflate.

Well-planned enjoyment! A dining area in which everything fits together perfectly thanks to a clear design language and exclusive surface design.





58-59

Moments of enjoyment



TOUCH

341 Lakklaminat. steinrå supermatt

341 Lacquered laminate, stone grey supermatt

TOUCH

340 Lakklaminat. sort supermatt

340 Lacquered laminate, black supermatt



INVITERE

INVITING

Kreativt planlagt! Friske urter er nå alltid innen rekkevidde på bordet. Skufferk tilbyr mye lagringsplass for briller og servise. Og utformingen av bordet fullfører generelle estetisk.

—
Creatively planned! Fresh herbs are now always within reach at the table. Pull-outs offer lots of storage space for glasses and crockery. And the design of the table completes the overall aesthetic.



60-61



Moments of enjoyment

HARMONI HARMONY

Det klassiske veggskapet ser flott ut med ytre og indre funksjoner og er et "mirakelrom" takket være praktiske uttrekk, skuffer og hylleplass. Kombinert med et matchende bord, sørger det for en ro og hjemmekoselig atmosfære.

The classic wall cupboard looks superb with its external and internal features and is a space miracle thanks to practical pull-outs, drawers and shelf space. Combined with the matching table, it makes for a calm and homely atmosphere.



TOUCH

334 Lakklaminat. skifergrå supermatt

334 Lacquered laminate, slate grey supermatt



KOMPLETT SORTIMENT COMPLETE RANGE

De varme Sierra eikeflatene kombinerer å bo og spise på en veldig moderne måte og sikrer et helhetlig design for rommet. Satingrå elementer understøtter perfekt denne avslappede stilen.

The warm Sierra oak surfaces combine living and eating in a very modern way and ensures a holistic design for the room. Silk grey elements perfectly underpin this relaxed style.





TOUCH

338 Lakklaminat. satingrå supermatt

338 Lacquered laminate, satin grey supermatt

STRUCTURA

405 Sierra eik etterlikning

405 Sierra oak reproduction



Kjærlighet for orden

A love of order

Det er ingen vei rundt gange for å komme til resten av huset. Enda bedre hvis du kan gjøre dette området til utstillingsvindu for gjester og få det bra organisert

—
There is no way around the hall to get to the rest of the house. Even better if you can make this area a showcase for guests and get it well organised.



NOK Plass

ENOUGH SPACE

Variasjont på sitt beste. Det stang-monterte hyllesystemet kan utvides etter ønske og blir et sant "mirakelrom" med skap, skuffer, hyller og kleskinner. Blikkfang: de stang-monterte hyllene kan eventuelt utstyres med integrert belysning.

Variability at its best. The pole-mounted shelving system can be extended at will and becomes a true space miracle with cupboards, pull-outs, shelves and clothes rails. Highlight: the pole-mounted shelving can be optionally equipped with integrated lighting.





TOUCH

334 Lakkaminat. skifergrå supermatt

334 Lacquered laminate, slate grey supermatt



68-69



A love of order



STRUCTURA

405 Sierra eik etterlikning

405 Sierra oak reproduction

EASYTOUCH

961 Lakklaminat. grafitt sort ultra matt

961 Lacquered laminate, graphite black ultra matt





ORGANISASJONSTALENT

ORGANISATIONAL TALENT

Dette henge- og skuffesystemet er et nyttig tillegg til enhver husholdning hver eneste dag. Med hyller, uttrekk og kleskinner hjelper det å organisere seg hverdagen. Praktisk: nøkler og mobiltelefoner kan lagres innen rekkevidde, og skjerfet og paraplyen din har et bestemt sted. Og så et raskt blikk i det opplyste speilet.

This hanging and drawer system is a useful addition to any household every day. With shelves, pull-outs and clothes rails, it helps to organise everyday life. Practical: keys and mobile phones can be stored within easy reach and your scarf and umbrella have a designated place. And then a quick glance in the illuminated mirror.





KONTRASTER

CONTRASTING PROGRAMME

Et steinutseende møter en valgfri indirekte lyssatt stang-montert hyllesystem som ser fantastisk ut med sine koordinerte skuffer, høye skuffer og et speil. En spennende kombinasjon som beriker hverdagen.

—
A quarry stone look meets an optional indirectly illuminated pole-mounted shelving system that looks stunning with its co-ordinated drawers, high pull-outs and a mirror. An exciting combination that enriches everyday life.



LUX

819 Lakk, satingrå høyglans

819 Lacquer, satin grey high gloss





Klesdrømmen

Clothing dreams

Å ha ditt eget garderobebehov trenger ikke forbli en drøm. Intelligente moduler og praktiske detaljløsninger kan tilpasses til alle størrelser på rommet og ta orden på livet på en stilig måte.

—
Having your own dressing room need not remain a dream. Intelligent modules and practical detail solutions can adapt to all sizes of room and bring order to life in a stylish way.



74-75



TOUCH

334 Lakkaminat, skifergrå supermatt

334 Lacquered laminate, slate grey supermatt

Clothing dreams



MER FLEKSIBILITET

GREATER FLEXIBILITY

Stilig og fleksibel på samme tid. Med hyller, skuffer, store skuffer og kleskinner, det variable stangmonterte hyllesystemet gir mye plass for klær og tilbehør og kan også utvides etter behov.

Stylish and flexible at the same time. With its shelves, drawers, pull-out drawers and clothes rails, the variable pole-mounted shelving system offers lots of space for clothing and accessories and can also be extended as required.



76-77

Clothing dreams



TOUCH

341 Lakkaminat, steinrå supermatt

341 Lacquered laminate, stone grey supermatt



ET MIRAKEL AV PLOSS

A SPACE MIRACLE

Det koselige klesområdet med mye plass for klær og andre favorittplagg tilbyr de perfekte forutsetningene for individuelle planer. Den perfekte syntesen av klassiske møbler og det stang-monterte hyllesystemet oppfyller de mest varierte krav.

—

The cosy dressing area with lots of space for clothing and other favourite pieces offers the ideal prerequisites for individual plans. The perfect synthesis of classic system furniture and the pole-mounted shelving system meets the most varied of demands.



PLANUNGSVORSCHLÄGE

Unsere Wohnmöbel können Sie immer individuell und passend für Ihre Bedürfnisse kombinieren. Ihr Fachhändler vor Ort unterstützt Sie gerne bei der Planung.

WSET02

Seite 14-17
page 14-17

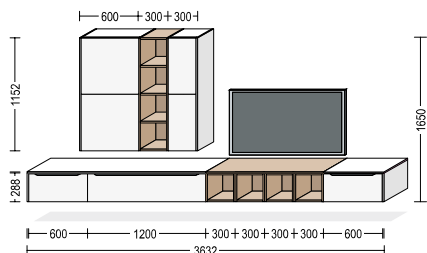

WSET06

Seite 24-27
page 24-27

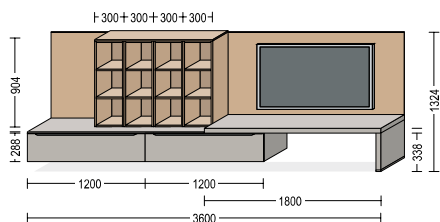

WSET16

Seite 34-35
page 34-35

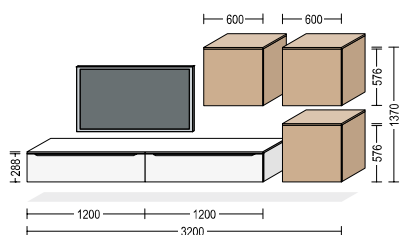

WSET12

Seite 44-47
page 44-47

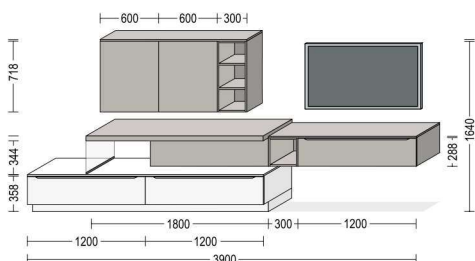

PLANNING SUGGESTIONS

You can always combine our furniture individually to suit your needs. Your local dealer will be happy to help you with your plans.

WSET01

Seite 18-19
page 18-19

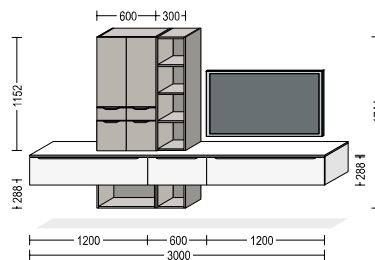

WSET09

Seite 28-29
page 28-29

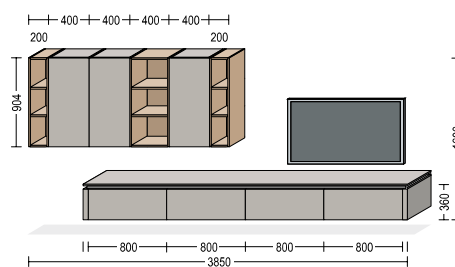

WSET08

Seite 36-39
page 36-39

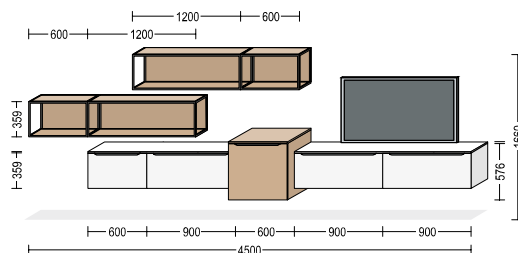

WSET07

Seite 48-49
page 48-49

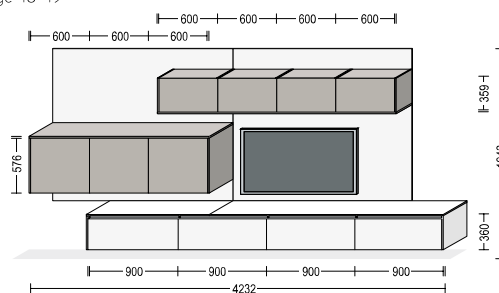

WSET05

Seite 20-21
page 20-21

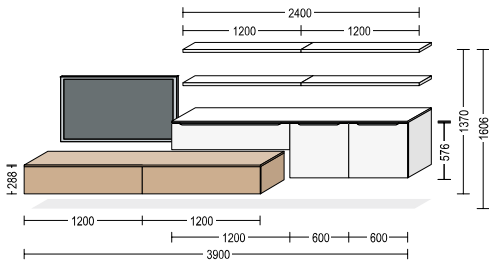

WSET04

Seite 22-23
page 22-23

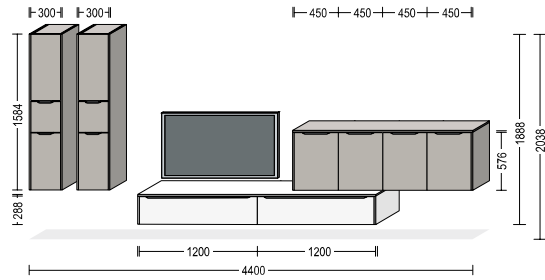

WSET11

Seite 30-31
page 30-31

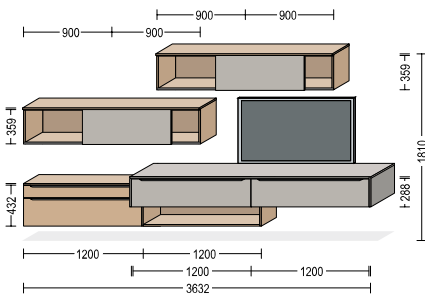

WSET15

Seite 32-33
page 32-33

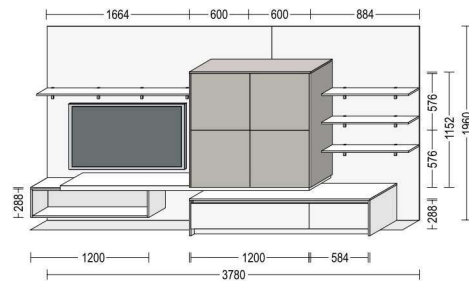

WSET13

Seite 40-41
page 40-41

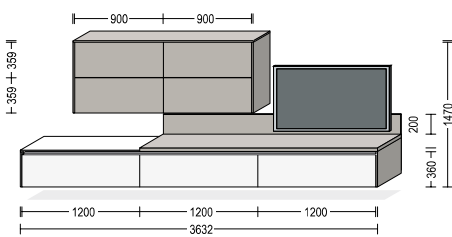

WSET14

Seite 42-43
page 42-43

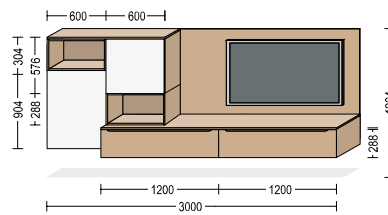

WSET03

Seite 50-51
page 50-51

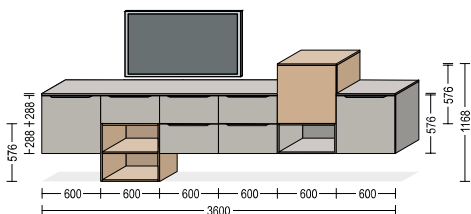

WSET10

Seite 52-53
page 52-53

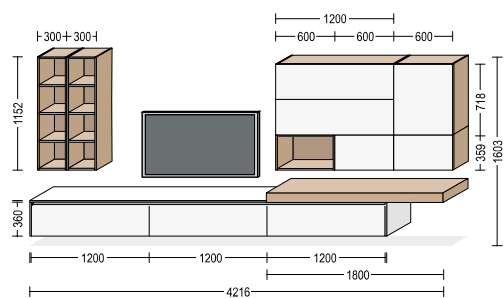

SPEZIFIKATIONEN SPECIFICATIONS

Die Planungsvorschläge enthalten keine Leuchten oder Griffleisten-Mehrpriese. Diese müssen zusätzlich zur Set-Artikelnnummer bestellt werden. Sondermaße gegen Mehrpreis. TV-Geräte und Dekorationsartikel sind nicht enthalten.

The planning suggestions do not include lights or surcharges for handles. These must be ordered in addition to the set item number. Special dimensions for a surcharge. TVs and decorative items are not included.

Wohngefühl Living atmosphere

WSET01

Seite 18-19
page 18-19

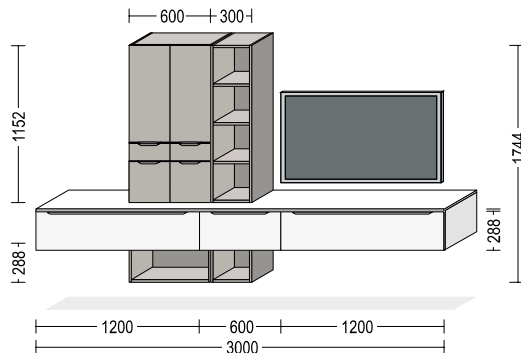

- | | |
|------------------------------------------------------------------------------------------------------------------------------------------------------------------------------------------------------------------------------------------------------------------------------------------------------------------------------------------------------------------------------------------------------------------------------------------------------------------------------------------------------------------------------------------------------------------------------------------------------------------------------------------------------------------------------|----------------------------------------------------------------------------------------------------------------------------------------------------------------------------------------------------------------------------------------------------------------------------------------------------------------------------------------------------------------------------------------------------------------------------------------------------------------------------------------------------------------------------------------------------------------------------------------------|
| <p>2 × BUA 120-29 Badezimmer-Auszugschrank, 1 Auszug, B × H × T: 1200 × 288 × 461 mm
Bathroom pull-out unit, 1 pull-out, w × h × d: 1200 × 288 × 461 mm</p> <p>1 × WR 60-36 Wandregal, B × H × T: 600 × Sondermaß 288 × 335 mm
Open shelf wall unit, w × h × d: 600 × special size 288 × 335 mm</p> <p>1 × WR 30-36 Wandregal, B × H × T: 300 × Sondermaß 288 × 335 mm
Open shelf wall unit, w × h × d: 300 × special size 288 × 335 mm</p> <p>1 × BUA 60-29 Badezimmer-Auszugschrank, 1 Auszug, B × H × T: 600 × 288 × 461 mm
Bathroom pull-out unit, 1 pull-out, w × h × d: 600 × 288 × 461 mm</p> | <p>1 × APSLN60 Arbeitsplatte APSLN Slim Line, 16 mm stark, B × T: 3004 × 487 mm
Worktop APSLN Slim Line, 16 mm thick, w × d: 3004 × 487 mm</p> <p>2 × BMSA 30-115 Badezimmer-Midischrank, 1 Tür, 1 Schubkasten, 1 Auszug, 2 Einlegeböden, B × H × T: 300 × 1152 × 320 mm
Bathroom Midi unit, 1 door, 1 drawer, 1 pull-out, 2 shelves, w × h × d: 300 × 1152 × 320 mm</p> <p>1 × BR 30-115 Badezimmer-Midiregal, 3 feste Böden, B × H × T: 300 × 1152 × 335 mm
Bathroom Midi shelf, 3 fixed shelves, w × h × d: 300 × 1152 × 335 mm</p> |
|------------------------------------------------------------------------------------------------------------------------------------------------------------------------------------------------------------------------------------------------------------------------------------------------------------------------------------------------------------------------------------------------------------------------------------------------------------------------------------------------------------------------------------------------------------------------------------------------------------------------------------------------------------------------------|----------------------------------------------------------------------------------------------------------------------------------------------------------------------------------------------------------------------------------------------------------------------------------------------------------------------------------------------------------------------------------------------------------------------------------------------------------------------------------------------------------------------------------------------------------------------------------------------|

WSET02

Seite 14-17
page 14-17

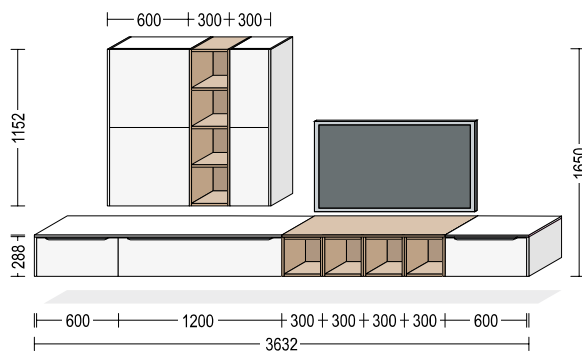

- | | |
|------------------------------------------------------------------------------------------------------------------------------------------------------------------------------------------------------------------------------------------------------------------------------------------------------------------------------------------------------------------------------------------------------------------------------------------------------------------------------------------------------------------------------------------------------------------------------------------------------------------------------------------------------------------------------------------------------------------------------------------------------------------------------------------------------------------------------------------------------------------------------------------------------------------------------------------------------------------------------------------------------------------------------------------------------------------------------|------------------------------------------------------------------------------------------------------------------------------------------------------------------------------------------------------------------------------------------------------------------------------------------------------------------------------------------------------------------------------------------------------------------------------------------------------------------------------------------------------------------------------------------------------------------------------------------------------------------------------------------------------------------------------------------------------------------------------------------------------------------------------------------------------------------|
| <p>2 × BUA 60-29 Badezimmer-Auszugschrank, 1 Auszug, B × H × T: 600 × 288 × 461 mm
Bathroom pull-out unit, 1 pull-out, w × h × d: 600 × 288 × 461 mm</p> <p>1 × BUA 120-29 Badezimmer-Auszugschrank, 1 Auszug, B × H × T: 1200 × 288 × 461 mm
Bathroom pull-out unit, 1 pull-out, w × h × d: 1200 × 288 × 461 mm</p> <p>4 × BUR 30-29 Badezimmer-Unterschrankregal, B × H × T: 300 × 288 × 482 mm
Bathroom open shelf base unit, w × h × d: 300 × 288 × 482 mm</p> <p>1 × ADB16 59 Abdeckboden, 16 mm stark, B × T: 1818 × 487 mm
Top shelf, 16 mm thick, w × d: 1818 × 487 mm</p> <p>1 × ADB16 59 Abdeckboden, 16 mm stark, B × T: 1200 × 487 mm
Top shelf, 16 mm thick, w × d: 1200 × 487 mm</p> <p>1 × ADB16 59 Abdeckboden, 16 mm stark, B × T: 618 × 487 mm
Top shelf, 16 mm thick, w × d: 618 × 487 mm</p> <p>2 × BUW 16-29 Abschlusswange, 16 mm stark, H × T: 288 × 485 mm
Upright at end of run, 16 mm thick, h × d: 288 × 485 mm</p> | <p>2 × W 60-01 Wandschrank, 1 Tür, 1 Einlegeboden, B × H × T: 600 × Sondermaß 576 × 320 mm
Wall unit, 1 door, 1 shelf, w × h × d: 600 × special size 576 × 320 mm</p> <p>1 × BR 30-115 Badezimmer-Midiregal, 3 feste Böden, B × H × T: 300 × 1152 × 335 mm
Bathroom Midi shelf, 3 fixed shelves, w × h × d: 300 × 1152 × 335 mm</p> <p>2 × W 30-01 Wandschrank, 1 Tür, 1 Einlegeboden, B × H × T: 300 × Sondermaß 576 × 320 mm
Wall unit, 1 door, 1 shelf, w × h × d: 300 × special size 576 × 320 mm</p> <p>2 × BMW 16-115 Abschlusswange, 16 mm stark, H × T: 1152 × 344 mm
Upright at end of run, 16 mm thick, h × d: 1152 × 344 mm</p> <p>1 × PT05 Mechanische Öffnungsunterstützung
Opening support mechanism</p> |
|------------------------------------------------------------------------------------------------------------------------------------------------------------------------------------------------------------------------------------------------------------------------------------------------------------------------------------------------------------------------------------------------------------------------------------------------------------------------------------------------------------------------------------------------------------------------------------------------------------------------------------------------------------------------------------------------------------------------------------------------------------------------------------------------------------------------------------------------------------------------------------------------------------------------------------------------------------------------------------------------------------------------------------------------------------------------------|------------------------------------------------------------------------------------------------------------------------------------------------------------------------------------------------------------------------------------------------------------------------------------------------------------------------------------------------------------------------------------------------------------------------------------------------------------------------------------------------------------------------------------------------------------------------------------------------------------------------------------------------------------------------------------------------------------------------------------------------------------------------------------------------------------------|

*Bitte beachten Sie, dass ein Distanzband für die Montage erforderlich ist, um Kollisionen zwischen der Front und den horizontal angebrachten Teilen zu vermeiden.
Please note that a spacer tape is required when planning top shelves and folding/lifting door and swivel flap units, to prevent the front contacting the top shelf.

Wohngefühl Living atmosphere

WSET03

Seite 50-51
page 50-51

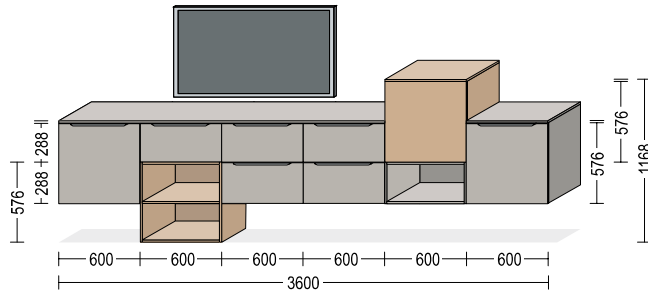

- | | | | |
|----------------|--------------------------------------------------------------------------------------------------------------------------------------------------------------------------------|---------------|------------------------------------------------------------------------------------------------------------------------------------|
| 3 × BU 60-58 | Badezimmer-Unterschrank, 1 Tür, 1 Einlegeboden,
B × H × T: 600 × 576 × 461 mm
Bathroom base unit, 1 door, 1 shelf, w × h × d: 600 × 576 × 461 mm | 1 × BUR 60-29 | Badezimmer-Unterschrankregal, B × H × T: 600 × 288 × 482 mm
Bathroom open shelf base unit, w × h × d: 600 × 288 × 482 mm |
| 1 × BUR 60-58 | Badezimmer-Unterschrankregal, 1 fester Boden,
B × H × T: 600 × 576 × 482 mm
Bathroom open shelf base unit, 1 fixed shelf,
w × h × d: 600 × 576 × 482 mm | 1 × ADB16 59 | Abdeckboden, 16 mm stark, B × T: 2402 × 487 mm
Top shelf, 16 mm thick, w × d: 2402 × 487 mm |
| 1 × BUA 60-29 | Badezimmer-Auszugschrank, 1 Auszug, B × H × T: 600 × 288 × 461 mm
Bathroom pull-out unit, 1 pull-out, w × h × d: 600 × 288 × 461 mm | 1 × ADB16 59 | Abdeckboden, 16 mm stark, B × T: 604 × 487 mm
Top shelf, 16 mm thick, w × d: 604 × 487 mm |
| 2 × BU2A 60-58 | Badezimmer-Auszugschrank, 2 Auszüge, B × H × T: 600 × 576 × 461 mm
Bathroom pull-out unit, 2 pull-outs, w × h × d: 600 × 576 × 461 mm | 1 × ADB16 59 | Abdeckboden, 16 mm stark, B × T: 602 × 487 mm
Top shelf, 16 mm thick, w × d: 602 × 487 mm |
| | | 1 × PTO5 | Mechanische Öffnungsunterstützung
Opening support mechanism |

WSET04*

Seite 22-23
page 22-23

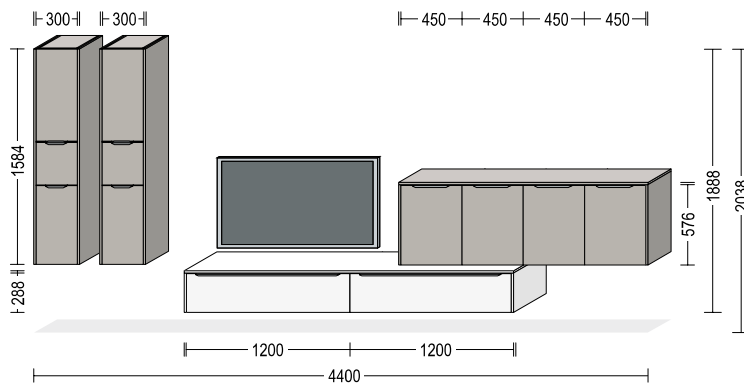

- | | | | |
|----------------|-----------------------------------------------------------------------------------------------------------------------------------------------------------------------------------------------------------------|---------------|------------------------------------------------------------------------------------------------------------------------------------------------------------------------------------------------|
| 2 × BMA 30-158 | Badezimmer-Midischrank, 1 Tür, 1 Auszug, 1 Tür, 3 Einlegeböden,
B × H × T: 300 × 1584 × 320 mm
Bathroom Midi unit, 1 door, 1 pull-out, 1 door, 3 shelves,
w × h × d: 300 × 1584 × 320 mm | 4 × BU 45-58 | Badezimmer-Unterschrank, 1 Tür, 1 Einlegeboden,
B × H × T: 450 × 576 × Sondermaß 320 mm
Bathroom base unit, 1 door, 1 shelf,
w × h × d: 450 × 576 × special size 320 mm |
| 4 × BMW 16-158 | Abschlusswange, 16 mm stark, H × T: 1584 × 344 mm
Upright at end of run, 16 mm thick, h × d: 1584 × 344 mm | 1 × ADB16 35 | Abdeckboden, 16 mm stark, B × T: 1836 × 346 mm
Top shelf, 16 mm thick, w × d: 1836 × 346 mm |
| 2 × BUA 120-29 | Badezimmer-Auszugschrank, 1 Auszug, B × H × T: 1200 × 288 × 461 mm
Bathroom pull-out unit, 1 pull-out, w × h × d: 1200 × 288 × 461 mm | 1 × BUW 16-58 | Abschlusswange, 16 mm stark, H × T: 576 × Sondermaß 344 mm
Upright at end of run, 16 mm thick, w × d: 576 × special size 344 mm |
| 1 × ADB16 59 | Abdeckboden, 16 mm stark, B × T: 2436 × 487 mm
Top shelf, 16 mm thick, w × d: 2436 × 487 mm | 1 × BUW 16-58 | Abschlusswange, 16 mm stark, H × T: 579 × Sondermaß 344 mm
Upright at end of run, 16 mm thick, w × d: 579 × special size 344 mm |
| 2 × BUW 16-29 | Abschlusswange, 16 mm stark, H × T: 288 × 485 mm
Upright at end of run, 16 mm thick, h × d: 288 × 485 mm | | |

SPEZIFIKATIONEN SPECIFICATIONS

Die Planungsvorschläge enthalten keine Leuchten oder Griffleisten-Mehrpriese. Diese müssen zusätzlich zur Set-Artikelnnummer bestellt werden. Sondermaße gegen Mehrpreis. TV-Geräte und Dekorationsartikel sind nicht enthalten.

The planning suggestions do not include lights or surcharges for handles. These must be ordered in addition to the set item number. Special dimensions for a surcharge. TVs and decorative items are not included.

Wohngefühl Living atmosphere

WSET05

Seite 20-21
page 20-21

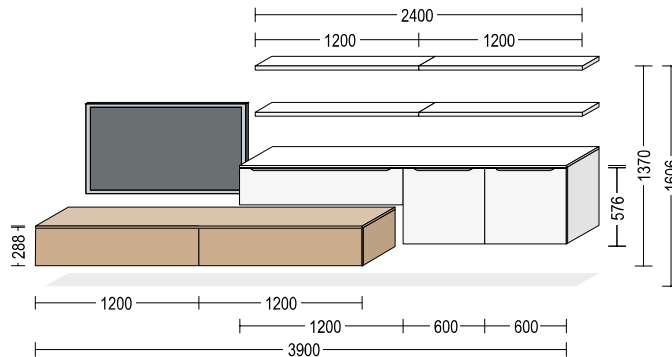

- | | | | |
|----------------|--------------------------------------------------------------------------------------------------------------------------------------------------------|--------------|--------------------------------------------------------------------------------------------------------------------------|
| 3 × BUA 120-29 | Badezimmer-Auszugschrank, 1 Auszug, B × H × T: 1200 × 288 × 461 mm
Bathroom pull-out unit, 1 pull-out, w × h × d: 1200 × 288 × 461 mm | 4 × WBLG 120 | LED Glas-Lichtbord, 30 mm stark, B × T: 1200 × 200 mm
LED glass lighted wall shelf, 30 mm thick, w × d: 1200 × 200 mm |
| 2 × SOS-SET | Sensomatic Öffnungssystem
Sensomatic opening system | 1 × LSET60 | LED-Startset
LED starter set |
| 2 × ADB16 59 | Abdeckboden, 16 mm stark, B × T: 2404 × 487 mm
Top shelf, 16 mm thick, w × d: 2404 × 487 mm | 1 × LFSET30 | LED-Folgeset
LED follow-up set |
| 2 × BU 60-58 | Badezimmer-Unterschrank, 1 Tür, 1 Einlegeboden,
B × H × T: 600 × 576 × 461 mm
Bathroom base unit, 1 door, 1 shelf, w × h × d: 600 × 576 × 461 mm | | |

WSET06

Seite 24-27
page 24-27

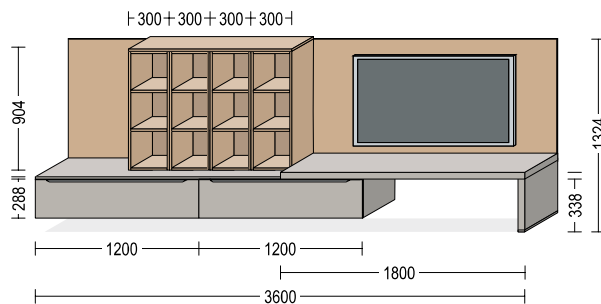

- | | | | |
|----------------|------------------------------------------------------------------------------------------------------------------------------------------|--------------|------------------------------------------------------------------------------------------------------------------------------------------------|
| 2 × BUA 120-29 | Badezimmer-Auszugschrank, 1 Auszug, B × H × T: 1200 × 288 × 461 mm
Bathroom pull-out unit, 1 pull-out, w × h × d: 1200 × 288 × 461 mm | 1 × ADB16 35 | Abdeckboden, 16 mm stark, B × T: 1204 × 337 mm
Top shelf, 16 mm thick, w × d: 1204 × 337 mm |
| 1 × ADB16 59 | Abdeckboden, 16 mm stark, B × T: 1802 × 487 mm
Top shelf, 16 mm thick, w × d: 1802 × 487 mm | 1 × ADB50 59 | Abdeckboden, 50 mm stark, B × T: 1800 × 487 mm
Top shelf, 50 mm thick, w × d: 1800 × 487 mm |
| 1 × NV203 | Nischenwandverkleidung, 16 mm stark, B × H: 602 × 904 mm
Niche cladding, 16 mm thick, w × h: 602 × 904 mm | 1 × UWA 50 | Abschlusswange inkl. Bodenprofil, 50 mm stark, H × T: 388 × 485 mm
Upright at end of run incl. floor seal, 50 mm thick, h × d: 388 × 485 mm |
| 4 × WR 30-03 | Wandregal, 2 feste Böden, B × H × T: 300 × 904 × 335 mm
Open shelf wall unit, 2 fixed shelves, w × h × d: 300 × 904 × 335 mm | 1 × NV203 | Nischenwandverkleidung, 16 mm stark, B × H: 1800 × 870 mm
Niche cladding, 16 mm thick, w × h: 1800 × 870 mm |

Wohngefühl Living atmosphere

WSET07

Seite 48-49
page 48-49

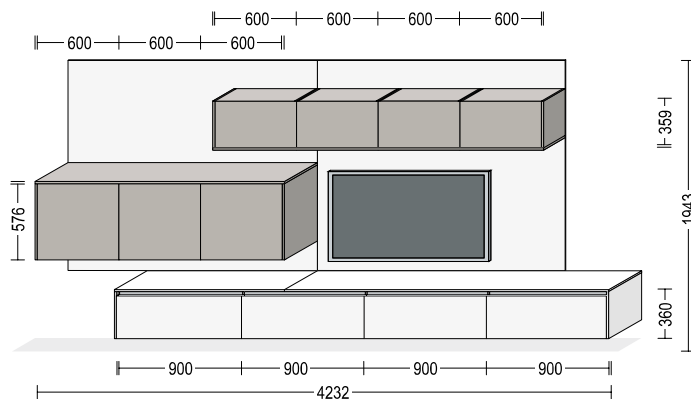

- | | | | |
|----------------|------------------------------------------------------------------------------------------------------------------------------------------------------------|--------------|--------------------------------------------------------------------------------------------------------------------------------------------------------------------------|
| 4 × NBUA 90-36 | Badezimmer-Auszugschrank, 1 Auszug, B × H × T: 900 × 360 × 461 mm
Bathroom pull-out unit, 1 pull-out, w × h × d: 900 × 360 × 461 mm | 2 × NV203 | Nischenwandverkleidung, 16 mm stark, B × H: 1816 × 1567 mm
Niche cladding, 16 mm thick, w × h: 1816 × 1567 mm |
| 1 × APSLN60 | Arbeitsplatte APSLN Slim Line, 16 mm stark, B × T: 1218 × 487 mm
Worktop APSLN Slim Line, 16 mm thick, w × d: 1218 × 487 mm | 4 × W 60-36 | Wandschrank, 1 Tür, B × H × T: 600 × 359 × 320 mm
Wall unit, 1 door, w × h × d: 600 × 359 × 320 mm |
| 1 × APSLN60 | Arbeitsplatte APSLN Slim Line, 16 mm stark, B × T: 2418 × 487 mm
Worktop APSLN Slim Line, 16 mm thick, w × d: 2418 × 487 mm | 1 × ADB16 35 | Abdeckboden, 16 mm stark, B × T: 2434 × 346 mm
Top shelf, 16 mm thick, w × d: 2434 × 346 mm |
| 2 × BUW 16-36 | Abschlusswange, 16 mm stark, H × T: 360 × 485 mm
Upright at end of run, 16 mm thick, h × d: 360 × 485 mm | 2 × WW 16-01 | Abschluss-/Zwischenwange, 16 mm stark, H × T: Sondermaß 359 × 344 mm
Upright at end of run/intermediate upright, 16 mm thick, h × d: special size 359 × 344 mm |
| 3 × BU 60-58 | Badezimmer-Unterschrank, 1 Tür, 1 Einlegeboden, B × H × T: 600 × 576 × 461 mm
Bathroom base unit, 1 door, 1 shelf, w × h × d: 600 × 576 × 461 mm | 2 × PTO5 | Mechanische Öffnungsunterstützung
Opening support mechanism |
| 1 × ADB16 59 | Abdeckboden, 16 mm stark, B × T: 1834 × 487 mm
Top shelf, 16 mm thick, w × d: 1834 × 487 mm | | |
| 2 × BUW 16-58 | Abschlusswange, 16 mm stark, H × T: 576 × 485 mm
Upright at end of run, 16 mm thick, h × d: 576 × 485 mm | | |

WSET08

Seite 36-39
page 36-39

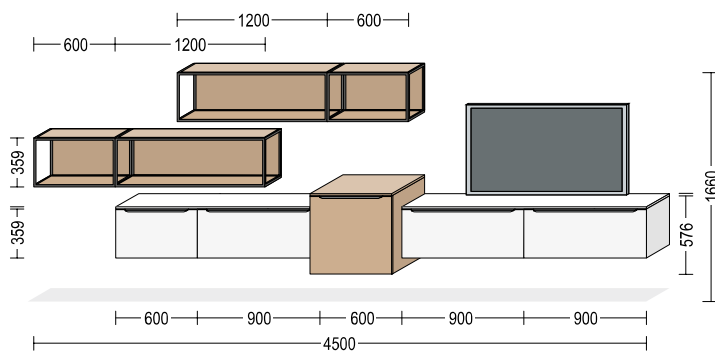

- | | | | |
|---------------|------------------------------------------------------------------------------------------------------------------------------------------------------------|-----------------|-------------------------------------------------------------------------------------------------------------------------------------------------|
| 1 × WKB 60-36 | Wandschrank mit Barklappe, 1 Klappe, B × H × T: 600 × 359 × 320 mm
Wall unit with bar flap, 1 flap, w × h × d: 600 × 359 × 320 mm | 2 × WRSC 60-36 | Wandregal Smartcube, B × H × T: 600 × 359 × 250 mm
Open shelf wall unit Smartcube, w × h × d: 600 × 359 × 250 mm |
| 3 × WKB 90-36 | Wandschrank mit Barklappe, 1 Klappe, B × H × T: 900 × 359 × 320 mm
Wall unit with bar flap, 1 flap, w × h × d: 900 × 359 × 320 mm | 2 × RKSC 60-36 | Rückwandverkleidung Smartcube, 16 mm stark, B × H: 600 × 321,5 mm
Back panel cladding Smartcube, 16 mm thick, w × h: 600 × 321.5 mm |
| 1 × ADB16 35 | Abdeckboden, 16 mm stark, B × T: 1502 × 346 mm
Top shelf, 16 mm thick, w × d: 1502 × 346 mm | 2 × WRSC 120-36 | Wandregal Smartcube, B × H × T: 1200 × 359 × 250 mm
Open shelf wall unit Smartcube, w × h × d: 1200 × 359 × 250 mm |
| 1 × BU 60-58 | Badezimmer-Unterschrank, 1 Tür, 1 Einlegeboden, B × H × T: 600 × 576 × 461 mm
Bathroom base unit, 1 door, 1 shelf, w × h × d: 600 × 576 × 461 mm | 2 × RKSC 120-36 | Rückwandverkleidung Smartcube, 16 mm stark, B × H: 1200 × 321,5 mm
Back panel cladding Smartcube, 16 mm thick, w × h: 1200 × 321.5 mm |
| 1 × ADB16 59 | Abdeckboden, 16 mm stark, B × T: 604 × 487 mm
Top shelf, 16 mm thick, w × d: 604 × 487 mm | 1 × PTO5 | Mechanische Öffnungsunterstützung
Opening support mechanism |
| 1 × ADB16 35 | Abdeckboden, 16 mm stark, B × T: 1802 × 346 mm
Top shelf, 16 mm thick, w × d: 1802 × 346 mm | | |

SPEZIFIKATIONEN SPECIFICATIONS

Die Planungsvorschläge enthalten keine Leuchten oder Griffleisten-Mehrpriese. Diese müssen zusätzlich zur Set-Artikelnummer bestellt werden. Sondermaße gegen Mehrpreis. TV-Geräte und Dekorationsartikel sind nicht enthalten.

The planning suggestions do not include lights or surcharges for handles. These must be ordered in addition to the set item number. Special dimensions for a surcharge. TVs and decorative items are not included.

Wohngefühl Living atmosphere

WSET09

Seite 28-29
page 28-29

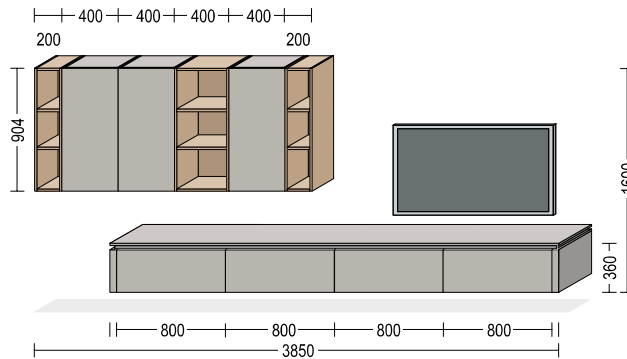

- | | | | |
|-----------------------|-----------------------------------------------------------------------------------------------------------------------------------------------|---------------------|-----------------------------------------------------------------------------------------------------------------------------------------|
| 4 × NBUA 80-36 | Badezimmer-Auszugschrank, 1 Auszug, B × H × T: 800 × 360 × 461 mm
Bathroom pull-out unit, 1 pull-out, w × h × d: 800 × 360 × 461 mm | 2 × WR 20-03 | Wandregal, 2 feste Böden, B × H × T: 200 × 904 × 335 mm
Open shelf wall unit, 2 fixed shelves, w × h × d: 200 × 904 × 335 mm |
| 1 × APSLN60 | Arbeitsplatte APSLN Slim Line, 16 mm stark, B × T: 3304 × 487 mm
Worktop APSLN Slim Line, 16 mm thick, w × d: 3304 × 487 mm | 3 × NW 40-03 | Wandschrank, 1 Tür, 2 Einlegeböden, B × H × T: 400 × 904 × 320 mm
Wall unit, 1 door, 2 shelves, w × h × d: 400 × 904 × 320 mm |
| 2 × NUWF36 50 | Abschluss-Frontwange, B × H × T: 50 × 360 × Sondermaß 482 mm
Front at end of run upright, w × h × d: 50 × 360 × special size 482 mm | 1 × WR 40-03 | Wandregal, 2 feste Böden, B × H × T: 400 × 904 × 335 mm
Open shelf wall unit, 2 fixed shelves, w × h × d: 400 × 904 × 335 mm |

WSET10

Seite 52-53
page 52-53

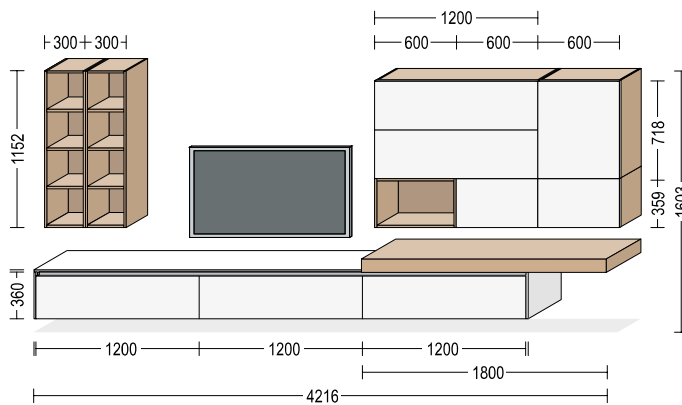

- | | | | |
|------------------------|----------------------------------------------------------------------------------------------------------------------------------------------------|-----------------------|-------------------------------------------------------------------------------------------------------------------------------------------------------------------------------------------------------------------------------------------------|
| 3 × NBUA 120-36 | Badezimmer-Auszugschrank, 1 Auszug, B × H × T: 1200 × 360 × 461 mm
Bathroom pull-out unit, 1 pull-out, w × h × d: 1200 × 360 × 461 mm | 2 × WKB 60-36 | Wandschrank mit Barklappe, 1 Klappe, B × H × T: 600 × 359 × 320 mm
Wall unit with bar flap, 1 flap, w × h × d: 600 × 359 × 320 mm |
| 1 × ADB16 59 | Abdeckboden, 16 mm stark, B × T: 2418 × 487 mm
Top shelf, 16 mm thick, w × d: 2418 × 487 mm | 1 × WFL 120-02 | Wandschrank falt-Lifttür, 1 falt-Lifttür, 2 Originalfronten, 2 Einlegeböden, B × H × T: 1200 × 718 × 320 mm
Wall unit with folding/lifting door, 1 folding/lifting door, 2 original fronts, 2 shelves, w × h × d: 1200 × 718 × 320 mm |
| 2 × BUW 16-36 | Abschlusswange, 16 mm stark, H × T: 360 × 485 mm
Upright at end of run, 16 mm thick, h × d: 360 × 485 mm | 1 × MP-SD | Mehrpriese Servo-Drive
Surcharge for servo motor |
| 1 × APP | Pultplatte, 100 mm stark, B × T: 1800 × 500 mm
Console panel, 100 mm thick, w × d: 1800 × 500 mm | 1 × W 60-02 | Wandschrank, 1 Tür, 2 Einlegeböden, B × H × T: 600 × 718 × 320 mm
Wall unit, 1 door, 2 shelves, w × h × d: 600 × 718 × 320 mm |
| 2 × BR 30-115 | Badezimmer-Midiregal, 3 feste Böden, B × H × T: 300 × 1152 × 335 mm
Bathroom Midi shelf, 3 fixed shelves, w × h × d: 300 × 1152 × 335 mm | 1 × PTOS | Mechanische Öffnungsunterstützung
Opening support mechanism |
| 1 × WR 60-36 | Wandregal, B × H × T: 600 × 359 × 335 mm
Open shelf wall unit, w × h × d: 600 × 359 × 335 mm | | |

Wohngefühl Living atmosphere

WSET11

Seite 30-31
page 30-31

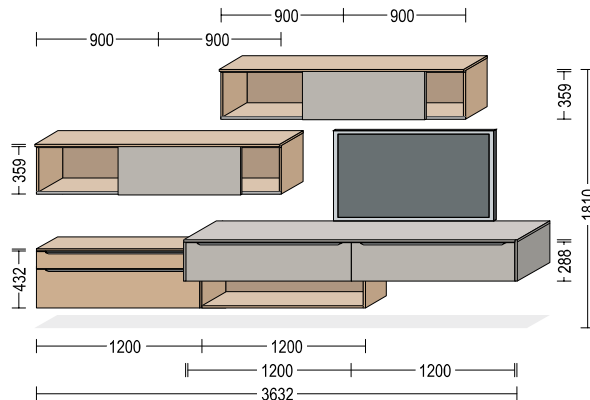

- 1 × BUSA 120-43 **Badezimmer-Auszugschrank, 1 Schubkasten, 1 Auszug, B × H × T: 1200 × 432 × Sondermaß 320 mm**
Bathroom pull-out unit, 1 drawer, 1 pull-out, w × h × d: 1200 × 432 × special size 320 mm
- 1 × ADB16 35 **Abdeckboden, 16 mm stark, B × T: 1202 × 346 mm**
Top shelf, 16 mm thick, w × d: 1202 × 346 mm
- 1 × WR 120-36 **Wandregal, B × H × T: 1200 × Sondermaß 288 × 335 mm**
Open shelf wall unit, w × h × d: 1200 × special size 288 × 335 mm
- 2 × BUA 120-29 **Badezimmer-Auszugschrank, 1 Auszug, B × H × T: 1200 × 288 × 461 mm**
Bathroom pull-out unit, 1 pull-out, w × h × d: 1200 × 288 × 461 mm
- 1 × ADB16 59 **Abdeckboden, 16 mm stark, B × T: 2436 × 487 mm**
Top shelf, 16 mm thick, w × d: 2436 × 487 mm

- 2 × BUW 16-29 **Abschlusswange, 16 mm stark, H × T: 288 × 485 mm**
Upright at end of run, 16 mm thick, h × d: 288 × 485 mm
- 4 × WSTK 90-36 **Wandschrank für Schiebetüren, B × H × T: 900 × 359 × 320 mm**
Wall unit for sliding doors, w × h × d: 900 × 359 × 320 mm
- 2 × WSTT 90-36 **Schiebetür, B × H: 900 × 359 mm**
Sliding door, w × h: 900 × 359 mm
- 2 × WSTP 250 **Laufprofil-Set für Schiebetüren, B × H × T: 1800 × 16 × 8 mm**
Runner profile set for sliding doors, w × h × d: 1800 × 16 × 8 mm
- 2 × ADB16 36 **Abdeckboden, 16 mm stark, B × T: 1804 × 353,5 mm**
Top shelf, 16 mm thick, w × d: 1804 × 353.5 mm

WSET12

Seite 44-47
page 44-47

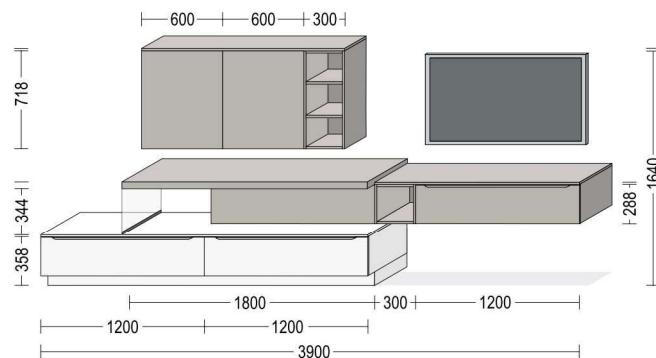

- 2 × UA 120-29 **Auszugschrank/Kochstellenschrank, 1 Auszug, B × H × T: 1200 × 288 × 561 mm**
Pull-out unit/hot plate unit, 1 pull-out, w × h × d: 1200 × 288 × 561 mm
- 2 × MP-PSO **Mehrpreis-Sockel**
Surcharge for plinth
- 1 × ADB16 59 **Abdeckboden, 16 mm stark, B × T: 2404 × 587 mm**
Top shelf, 16 mm thick, w × d: 2404 × 587 mm
- 1 × UWG 34 **Glaswange, 8 mm stark, H × T: 360 × 585 mm**
Glass upright, 8 mm thick, h × d: 360 × 585 mm
- 1 × ADB50 59 **Abdeckboden, 50 mm stark, B × T: 1800 × 587 mm**
Top shelf, 50 mm thick, w × d: 1800 × 587 mm
- 2 × BUA 120-29 **Badezimmer-Auszugschrank, 1 Auszug, B × H × T: 1200 × 288 × 461 mm**
Bathroom pull-out unit, 1 pull-out, w × h × d: 1200 × 288 × 461 mm

- 1 × BUR 30-29 **Badezimmer-Unterschrankregal, B × H × T: 300 × 288 × 482 mm**
Bathroom open shelf base unit, w × h × d: 300 × 288 × 482 mm
- 1 × ADB16 59 **Abdeckboden, 16 mm stark, B × T: 1502 × 487 mm**
Top shelf, 16 mm thick, w × d: 1502 × 487 mm
- 2 × W 60-02 **Wandschrank, 1 Tür, 2 Einlegeböden, B × H × T: 600 × 718 × 320 mm**
Wall unit, 1 door, 2 shelves, w × h × d: 600 × 718 × 320 mm
- 1 × WR 30-02 **Wandregal, 2 feste Böden, B × H × T: 300 × 718 × 335 mm**
Open shelf wall unit, 2 fixed shelves, w × h × d: 300 × 718 × 335 mm
- 1 × ADB16 36 **Abdeckboden, 16 mm stark, B × T: 1504 × 346 mm**
Top shelf, 16 mm thick, w × d: 1504 × 346 mm
- 1 × PTO5 **Mechanische Öffnungsunterstützung**
Opening support mechanism

SPEZIFIKATIONEN SPECIFICATIONS

Die Planungsvorschläge enthalten keine Leuchten oder Griffleisten-Mehrpriese. Diese müssen zusätzlich zur Set-Artikelnnummer bestellt werden. Sondermaße gegen Mehrpreis. TV-Geräte und Dekorationsartikel sind nicht enthalten.

The planning suggestions do not include lights or surcharges for handles. These must be ordered in addition to the set item number. Special dimensions for a surcharge. TVs and decorative items are not included.

Wohngefühl Living atmosphere

WSET13

Seite 40-41
page 40-41

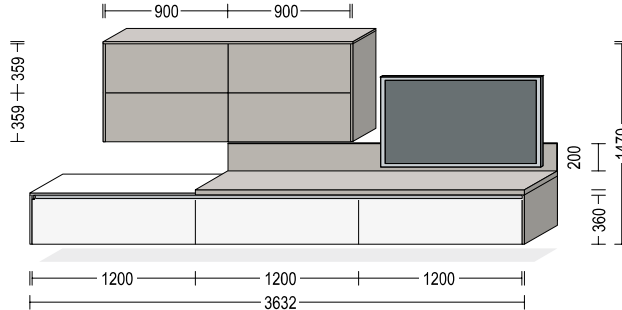

- | | | | |
|-----------------|------------------------------------------------------------------------------------------------------------------------------------------|----------------|--------------------------------------------------------------------------------------------------------------------------------------------|
| 3 × NBUA 120-36 | Badezimmer-Auszugschrank, 1 Auszug, B × H × T: 1200 × 360 × 461 mm
Bathroom pull-out unit, 1 pull-out, w × h × d: 1200 × 360 × 461 mm | 2 × NBUW 16-36 | LINE N-Abschlusswange, 16 mm stark, H × T: 360 × 482 mm
LINE N upright at end of run, 16 mm thick, h × d: 360 × 482 mm |
| 1 × ADB16 59 | Abdeckboden, 16 mm stark, B × T: 1218 × 487 mm
Top shelf, 16 mm thick, w × d: 1218 × 487 mm | 4 × WKB 90-36 | Wandschrank mit Barklappe, 1 Klappe, B × H × T: 900 × 359 × 320 mm
Wall unit with bar flap, 1 flap, w × h × d: 900 × 359 × 320 mm |
| 1 × APD60 | Arbeitsplatte APD, 38 mm stark, B × T: 2418 × 487 mm
Worktop APD, 38 mm thick, w × d: 2418 × 487 mm | 1 × ADB16 35 | Abdeckboden, 16 mm stark, B × T: 1836 × 346 mm
Top shelf, 16 mm thick, w × d: 1836 × 346 mm |
| 1 × NV203 | Nischenwandverkleidung, 16 mm stark, B × H: 2418 × 200 mm
Niche cladding, 16 mm thick, w × h: 2418 × 200 mm | 2 × WW 16-02 | Abschluss-/Zwischenwange, 16 mm stark, H × T: 718 × 344 mm
Upright at end of run/intermediate upright, 16 mm thick, h × d: 718 × 344 mm |

WSET14

Seite 42-43
page 42-43

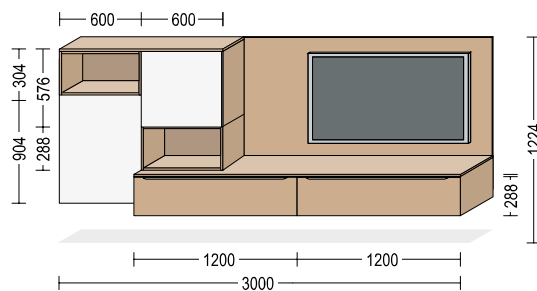

- | | | | |
|----------------|----------------------------------------------------------------------------------------------------------------------------------------------------------------------------|--------------|----------------------------------------------------------------------------------------------------------------|
| 1 × W 60-03 | Wandschrank, 1 Tür, 2 Einlegeböden, B × H × T: 600 × 904 × 320 mm
Wall unit, 1 door, 2 shelves, w × h × d: 600 × 904 × 320 mm | 1 × ADB16 35 | Abdeckboden, 16 mm stark, B × T: 1204 × 346 mm
Top shelf, 16 mm thick, w × d: 1204 × 346 mm |
| 1 × WR 60-36 | Wandregal, B × H × T: 600 × Sondermaß 304 × 335 mm
Open shelf wall unit, w × h × d: 600 × special size 304 × 335 mm | 1 × ADB16 59 | Abdeckboden, 16 mm stark, B × T: 2402 × 487 mm
Top shelf, 16 mm thick, w × d: 2402 × 487 mm |
| 2 × BUA 120-29 | Badezimmer-Auszugschrank, 1 Auszug, B × H × T: 1200 × 288 × 461 mm
Bathroom pull-out unit, 1 pull-out, w × h × d: 1200 × 288 × 461 mm | 1 × NV203 | Nischenwandverkleidung, 16 mm stark, B × H: 1802 × 904 mm
Niche cladding, 16 mm thick, w × h: 1802 × 904 mm |
| 1 × WR 60-36 | Wandregal, B × H × T: 600 × Sondermaß 328 × 335 mm
Open shelf wall unit, w × h × d: 600 × special size 328 × 335 mm | | |
| 1 × BU 60-58 | Badezimmer-Unterschrank, 1 Tür, 1 Einlegeboden, B × H × T: 600 × 576 × Sondermaß 320 mm
Bathroom base unit, 1 door, 1 shelf, w × h × d: 600 × 576 × special size 320 mm | | |

Wohngefühl Living atmosphere

WSET15

Seite 32-33
page 32-33

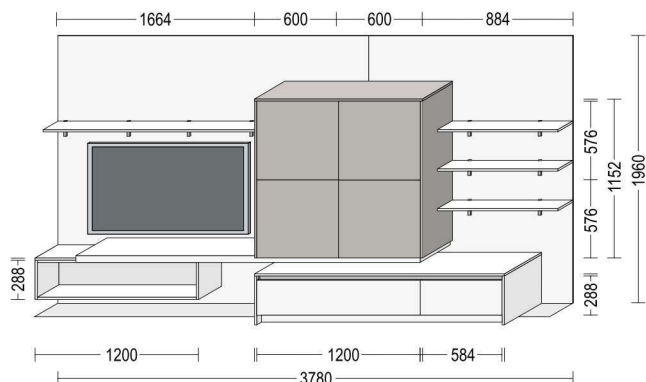

- | | | | |
|---------------|---------------------------------------------------------------------------------------------------------------------------------------------------------------|--------------|--------------------------------------------------------------------------------------------------------------------------------------------------------------------|
| 1 × WR 120-36 | Wandregal, B × H × T: 1200 × Sondermaß 288 × 335 mm
Open shelf wall unit, w × h × d: 1200 × special size 288 × 335 mm | 1 × ADB16 59 | Abdeckboden, 16 mm stark, B × T: 1836 × 487 mm
Top shelf, 16 mm thick, w × d: 1836 × 487 mm |
| 1 × ADB16 35 | Abdeckboden, 16 mm stark, B × T: 302 × 346 mm
Top shelf, 16 mm thick, w × d: 302 × 346 mm | 2 × UWA16 | Abschlusswange inkl. Bodenprofil, 16 mm stark, H × T: 358 × 585 mm
Upright at end of run incl. floor seal, 16 mm thick, h × d: 358 × 585 mm |
| 1 × NV203 | Nischenwandverkleidung, 16 mm stark, B × H: 2280 × 1960 mm
Niche cladding, 16 mm thick, w × h: 2280 × 1960 mm | 4 × BU 60-58 | Badzimmer-Unterschrank, 1 Tür, 1 Einlegeboden, B × H × T: 600 × 576 × 461 mm
Bathroom base unit, 1 door, 1 shelf, w × h × d: 600 × 576 × 461 mm |
| 1 × VB16 258 | Wandbord, 16 mm stark, B × T: 1664 × 255 mm
Wall shelf, 16 mm thick, w × d: 1664 × 255 mm | 1 × ADB16 59 | Abdeckboden, 16 mm stark, B × T: 1236 × 487 mm
Top shelf, 16 mm thick, w × d: 1236 × 487 mm |
| 1 × ADB50 59 | Abdeckboden, 50 mm stark, B × T: 2580 × 461 mm
Top shelf, 50 mm thick, w × d: 2580 × 461 mm | 2 × HWK 16 | Abschlusswange, 16 mm stark, H × T: Sondermaß 1152 × Sondermaß 485 mm
Upright at end of run, 16 mm thick, h × d: special size 1152 × special size 485 mm |
| 1 × UA 120-29 | Auszugschrank/Kochstellenschrank, 1 Auszug, B × H × T: 1200 × 288 × 561 mm
Pull-out unit/hot plate unit, 1 pull-out, w × h × d: 1200 × 288 × 561 mm | 1 × NV203 | Nischenwandverkleidung, 16 mm stark, B × H: 1500 × 1960 mm
Niche cladding, 16 mm thick, w × h: 1500 × 1960 mm |
| 2 × MP-PSO | Mehrp reis-Sockel
Surcharge for plinth | 3 × VB16 100 | Wandbord, 16 mm stark, B × T: 884 × 255 mm
Wall shelf, 16 mm thick, w × d: 884 × 255 mm |
| 1 × UA 60-29 | Auszugschrank/Kochstellenschrank, 1 Auszug, B × H × T: 600 × 288 × 561 mm
Pull-out unit/hot plate unit, 1 pull-out, w × h × d: 600 × 288 × 561 mm | 1 × PTO5 | Mechanische Öffnungsunterstützung
Opening support mechanism |

WSET16

Seite 34-35
page 34-35

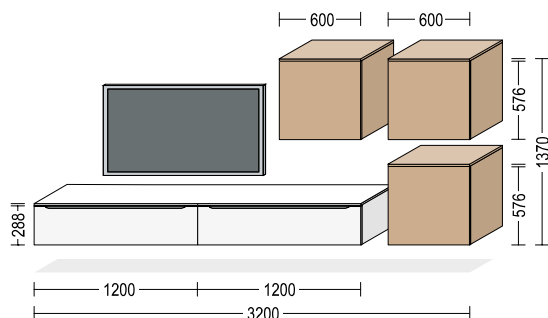

- | | | | |
|----------------|-----------------------------------------------------------------------------------------------------------------------------------------------------------|--------------|-----------------------------------------------------------------------------------------------------|
| 2 × BUA 120-29 | Badzimmer-Auszugschrank, 1 Auszug, B × H × T: 1200 × 288 × 461 mm
Bathroom pull-out unit, 1 pull-out, w × h × d: 1200 × 288 × 461 mm | 3 × ADB16 59 | Abdeckboden, 16 mm stark, B × T: 604 × 487 mm
Top shelf, 16 mm thick, w × d: 604 × 487 mm |
| 1 × ADB16 59 | Abdeckboden, 16 mm stark, B × T: 2404 × 487 mm
Top shelf, 16 mm thick, w × d: 2404 × 487 mm | 1 × PTO5 | Mechanische Öffnungsunterstützung
Opening support mechanism |
| 3 × BU 60-58 | Badzimmer-Unterschrank, 1 Tür, 1 Einlegeboden, B × H × T: 600 × 576 × 461 mm
Bathroom base unit, 1 door, 1 shelf, w × h × d: 600 × 576 × 461 mm | | |

SPEZIFIKATIONEN SPECIFICATIONS

Die Planungsvorschläge enthalten keine Leuchten oder Griffleisten-Mehrpriese. Diese müssen zusätzlich zur Set-Artikelnummer bestellt werden. Sondermaße gegen Mehrpreis. TV-Geräte und Dekorationsartikel sind nicht enthalten.

The planning suggestions do not include lights or surcharges for handles. These must be ordered in addition to the set item number. Special dimensions for a surcharge. TVs and decorative items are not included.

Genussmoment Moments of enjoyment

DINSET01

Seite 62-63
page 62-63

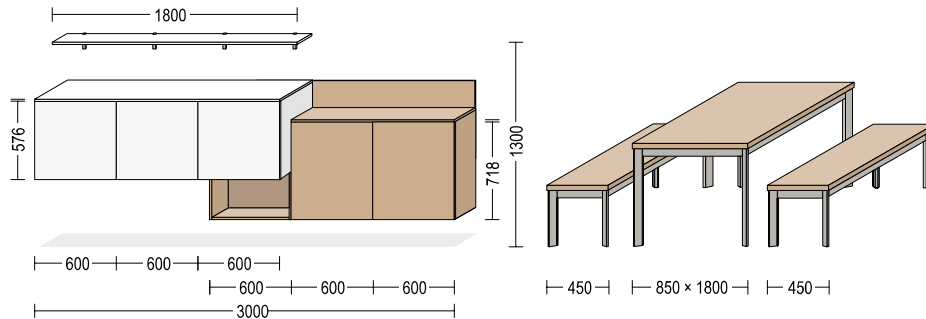

- 3 × BU 60-58** **Badezimmer-Unterschrank, 1 Tür, 1 Einlegeboden, B × H × T: 600 × 576 × 461 mm**
Bathroom base unit, 1 door, 1 shelf, w × h × d: 600 × 576 × 461 mm
- 1 × WR 60-36** **Wandregal, B × H × T: 600 × 359 × 335 mm**
Open shelf wall unit, w × h × d: 600 × 359 × 335 mm
- 1 × ADB16 59** **Abdeckboden, 16 mm stark, B × T: 1804 × 487 mm**
Top shelf, 16 mm thick, w × d: 1804 × 487 mm
- 2 × W 60-02** **Wandschrank, 1 Tür, 2 Einlegeböden, B × H × T: 600 × 718 × 320 mm**
Wall unit, 1 door, 2 shelves, w × h × d: 600 × 718 × 320 mm
- 1 × ADB16 36** **Abdeckboden, 16 mm stark, B × T: 1202 × 346 mm**
Top shelf, 16 mm thick, w × d: 1202 × 346 mm
- 1 × NV203** **Nischenwandverkleidung, 16 mm stark, B × H: 1202 × 201 mm**
Niche cladding, 16 mm thick, w × h: 1202 × 201 mm
- 1 × VB16 258** **Wandbord mit Bodenhaltern, 16 mm stark, B × T: 1804 × 255 mm**
Wall shelf unit with shelf holders, 16 mm thick, w × d: 1804 × 255 mm

- 1 × PTO5** **Mechanische Öffnungsunterstützung**
Opening support mechanism
- 2 × ABGF 180** **Bankgestell, B × H × T: 1792 × 415 × 442 mm**
Bench base, w × h × d: 1792 × 415 × 442 mm
- 2 × APD60** **Arbeitsplatte APD mit Dekorkante, 38 mm stark, B × T: 1800 × 450 mm**
Worktop APD with décor edge, 38 mm thick, w × d: 1800 × 450 mm
- 1 × ATGF180** **Tischgestell, B × H × T: 1792 × 720 × 842 mm**
Table frame, w × h × d: 1792 × 720 × 842 mm
- 1 × APD90** **Arbeitsplatte APD mit Dekorkante, 38 mm stark, B × T: 1800 × 850 mm**
Worktop APD with décor edge, 38 mm thick, w × d: 1800 × 850 mm
- 3 × APD-K** **Mehrpriese für zusätzliche Kantenbelegung**
Surcharge for additional edging

DINSET02

Seite 54-57
page 54-57

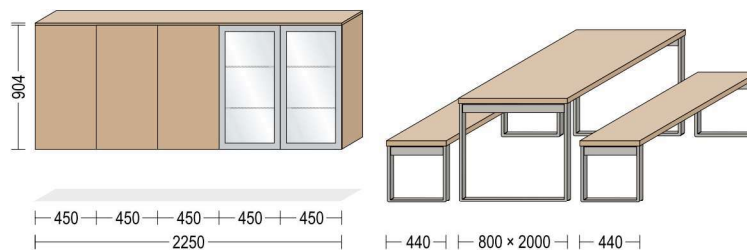

- 3 × W 45-03** **Wandschrank, 1 Tür, 2 Einlegeböden, B × H × T: 450 × 904 × 320 mm**
Wall unit, 1 door, 2 shelves, w × h × d: 450 × 904 × 320 mm
- 2 × WSQ 45-03** **Glas-Wandschrank Square, 1 Alu-Rahmentür, 2 Glaseinlegeböden, B × H × T: 450 × 904 × 320 mm**
Wall unit with glass doors Square, 1 aluminium framed door, 2 glass shelves, w × h × d: 450 × 904 × 320 mm
- 1 × ADB16 35** **Abdeckboden, 16 mm stark, B × T: 2254 × 346 mm**
Top shelf, 16 mm thick, w × d: 2254 × 346 mm
- 1 × PTO5** **Mechanische Öffnungsunterstützung**
Opening support mechanism
- 2 × ABG** **Bankgestell, H × T: 415 × 430 mm, 1490 - 2490 mm lang**
Bench base, h × d: 415 × 430 mm, 1490 - 2490 mm long
- 2 × APD60** **Arbeitsplatte APD mit Dekorkante, 38 mm stark, B × T: 2000 × 440 mm**
Worktop APD with décor edge, 38 mm thick, w × d: 2000 × 440 mm
- 1 × ATG-E** **Tischgestell, H × T: 720 × 790 mm, 1490 - 2490 mm lang**
Table frame, h × d: 720 × 790 mm, 1490 - 2490 mm long
- 1 × APD80** **Arbeitsplatte APD mit Dekorkante, 38 mm stark, B × T: 2000 × 800 mm**
Worktop APD with décor edge, 38 mm thick, w × d: 2000 × 800 mm
- 3 × APD-K** **Mehrpriese für zusätzliche Kantenbelegung**
Surcharge for additional edging

*Bitte beachten Sie, dass ein Distanzband für die Montage erforderlich ist, um Kollisionen zwischen der Front und den horizontal angebrachten Teilen zu vermeiden.
Please note that a spacer tape is required when planning top shelves and folding/lifting door and swivel flap units, to prevent the front contacting the top shelf.

Genussmoment Moments of enjoyment

DINSET03*

Seite 60-61
page 60-61

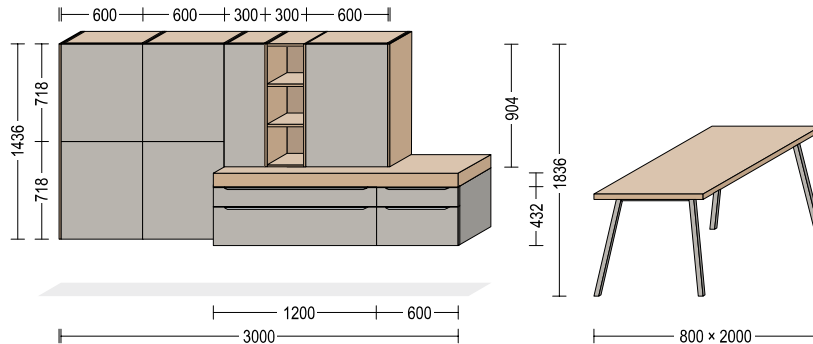

4 × W 60-02 **Wandschrank, 1 Tür, 2 Einlegeböden, B × H × T: 600 × 718 × 320 mm**
Wall unit, 1 door, 2 shelves, w × h × d: 600 × 718 × 320 mm

1 × HWK 16 **Abschlusswange, 16 mm stark, H × T: 1440 × 344 mm**
Upright at end of run, 16 mm thick, h × d: 1440 × 344 mm

1 × BUSA 120-43 **Badezimmer-Auszugschrank, 1 Schubkasten, 1 Auszug, B × H × T: 1200 × 432 × 461 mm**
Bathroom pull-out unit, 1 drawer, 1 pull-out, w × h × d: 1200 × 432 × 461 mm

1 × BUSA 60-43 **Badezimmer-Auszugschrank, 1 Schubkasten, 1 Auszug, B × H × T: 600 × 432 × 461 mm**
Bathroom pull-out unit, 1 pull-out, w × h × d: 600 × 432 × 461 mm

1 × APP **Pultplatte, 100 mm stark, B × T: 1800 × 487 mm**
Console panel, 100 mm thick, w × d: 1800 × 487 mm

2 × W 30-03 **Wandschrank, 1 Tür, 2 Einlegeböden, B × H × T: 300 × 904 × 320 mm**
Wall unit, 1 door, 2 shelves, w × h × d: 300 × 904 × 320 mm

1 × WR 30-03 **Wandregal, 2 feste Böden, B × H × T: 300 × 904 × 335 mm**
Open shelf wall unit, 2 fixed shelves, w × h × d: 300 × 904 × 335 mm

1 × W 60-03 **Wandschrank, 1 Tür, 2 Einlegeböden, B × H × T: 600 × 904 × 320 mm**
Wall unit, 1 door, 2 shelves, w × h × d: 600 × 904 × 320 mm

1 × WW 16-03 **Abschluss-/Zwischenwange, 16 mm stark, H × T: 907 × 344 mm**
Upright at end of run/intermediate upright, 16 mm thick, h × d: 907 × 344 mm

1 × ATGT-E **Tischgestell, H × T: 711 × 800 mm, 1400 - 2000 mm lang**
Table frame, h × d: 711 × 800 mm, 1400 - 2000 mm long

1 × APD80 **Arbeitsplatte APD mit Dekorkante, 38 mm stark, B × T: 2000 × 800 mm**
Worktop APD with décor edge, 38 mm thick, w × d: 2000 × 800 mm

1 × APD-K **Mehrpriß für zusätzliche Kantenbelegung**
Surcharge for additional edging

DINSET04

Seite 58-59
page 58-59

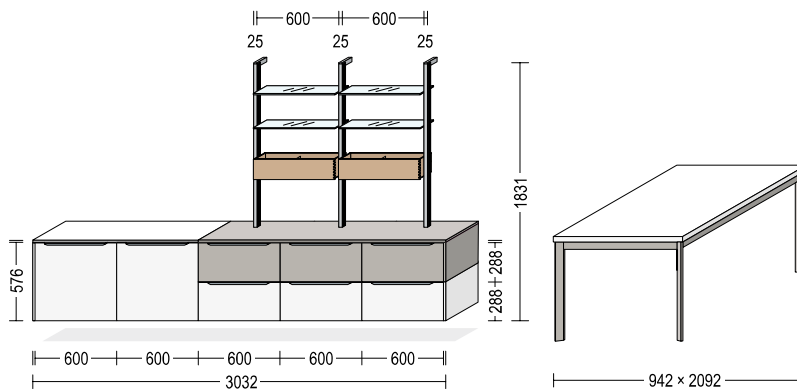

2 × BU 60-58 **Badezimmer-Unterschrank, 1 Tür, 1 Einlegeboden, B × H × T: 600 × 576 × 461 mm**
Bathroom base unit, 1 door, 1 shelf, w × h × d: 600 × 576 × 461 mm

1 × ADB16 59 **Abdeckboden, 16 mm stark, B × T: 1218 × 487 mm**
Top shelf, 16 mm thick, w × d: 1218 × 487 mm

1 × BUW 16-58 **Abschlusswange, 16 mm stark, H × T: 576 × 485 mm**
Upright at end of run, 16 mm thick, h × d: 576 × 485 mm

6 × BUA 60-29 **Badezimmer-Auszugschrank, 1 Auszug, B × H × T: 600 × 288 × 461 mm**
Bathroom pull-out unit, 1 pull-out, w × h × d: 600 × 288 × 461 mm

1 × ADB16 59 **Abdeckboden, 16 mm stark, B × T: 1818 × 487 mm**
Top shelf, 16 mm thick, w × d: 1818 × 487 mm

2 × BUW 16-29 **Abschlusswange, 16 mm stark, H × T: 288 × 485 mm**
Upright at end of run, 16 mm thick, h × d: 288 × 485 mm

3 × ARS 15-02 **Aluminiumstollen in Aufsatzschrankhöhe O2, T: 150 mm**
Aluminium support poles in dresser unit height O2, d: 150 mm

4 × RSG 60 **Glasboden, 8 mm stark, B × T: 600 × 220 mm**
Glass shelf, 8 mm thick, w × d: 600 × 220 mm

2 × RSHK 60-H **Holzkasten, B × H × T: 600 × 150 × 170 mm**
Wooden box, w × h × d: 600 × 150 × 170 mm

2 × RSKRS 60-H **Kunststoff Kräuterschale, 2 Stück, B × H: 600 × 125 mm**
Plastic herb pot, 2 pieces, w × h: 600 × 125 mm

1 × ATGO 210-S **Tischgestell Otello, H × T: 732 × 942 mm, 2092 mm lang**
Table frame Otello, h × d: 732 × 942 mm, 2092 mm long

1 × APD100 **Arbeitsplatte APD mit Dekorkante, 38 mm stark, B × T: 2100 × 950 mm**
Worktop APD with décor edge, 38 mm thick, w × d: 2100 × 950 mm

1 × APD-K **Mehrpriß für zusätzliche Kantenbelegung**
Surcharge for additional edging

SPEZIFIKATIONEN SPECIFICATIONS

Die Planungsvorschläge enthalten keine Leuchten oder Griffleisten-Mehrpriese. Diese müssen zusätzlich zur Set-Artikelnummer bestellt werden.

Sondermaße gegen Mehrpreis. TV-Geräte und Dekorationsartikel sind nicht enthalten.

The planning suggestions do not include lights or surcharges for handles. These must be ordered in addition to the set item number.

Special dimensions for a surcharge. TVs and decorative items are not included.

Ordnungsliebe A love of order

GSET01

Seite 64-67
page 64-67

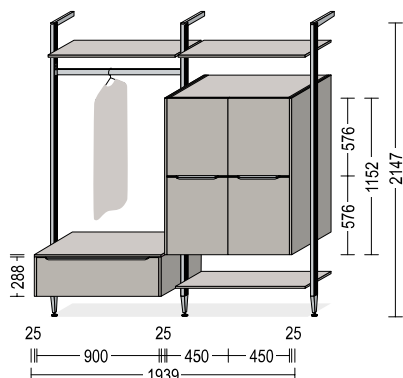

3 × HRS 30-02 Aluminiumstollen in Hochschrankhöhe 02, T: 295 mm
Aluminium support poles in tall unit height 02, d: 295 mm

1 × BUA 90-29 Badezimmer-Auszugschrank, 1 Auszug, B × H × T: 900 × 288 × 461 mm
Bathroom pull-out unit, 1 pull-out, w × h × d: 900 × 288 × 461 mm

1 × ADB16 59 Abdeckboden, 16 mm stark, B × T: 932 × 487 mm
Top shelf, 16 mm thick, w × d: 932 × 487 mm

2 × BUW 16-29 Abschlusswange, 16 mm stark, H × T: 288 × 485 mm
Upright at end of run, 16 mm thick, h × d: 288 × 485 mm

1 × RSKST 93 Kleiderstange, B: 932 mm
Clothes rail, w: 932 mm

3 × RSB16 90-38 Regalboden, 16 mm stark, B × T: Sondermaß 932 × 380 mm
Shelf, 16 mm thick, w × d: special size 932 × 380 mm

2 × HWK 16 Abschlusswange, 16 mm stark, H × T: 1152 × 485 mm
Upright at end of run, 16 mm thick, h × d: 1152 × 485 mm

4 × BU 45-58 Badezimmer-Unterschrank, 1 Tür, 1 Einlegeboden, B × H × T: 450 × 576 × 461 mm
Bathroom base unit, 1 door, 1 shelf, w × h × d: 450 × 576 × 461 mm

3 × RSSK Schrank-Konnektor
Unit connector

GSET02

Seite 68-69
page 68-69

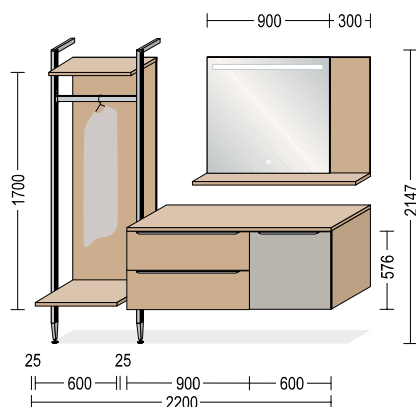

2 × HRS 30-02 Aluminiumstollen in Hochschrankhöhe 02, T: 295 mm
Aluminium support poles in tall unit height 02, d: 295 mm

2 × RSB25 60-38 Regalboden, 25 mm stark, B × T: 600 × 380 mm
Shelf, 25 mm thick, w × d: 600 × 380 mm

1 × RSKST 60 Kleiderstange, B: 600 mm
Clothes rail, w: 600 mm

1 × NV203 Nischenwandverkleidung, 16 mm stark, B × H: 600 × 1700 mm
Niche cladding, 16 mm thick, w × h: 600 × 1700 mm

1 × BU2A 90-58 Badezimmer-Auszugschrank, 2 Auszüge, B × H × T: 900 × 576 × 461 mm
Bathroom pull-out unit, 2 pull-outs, w × h × d: 900 × 576 × 461 mm

1 × BU 60-58 Badezimmer-Unterschrank, 1 Tür, 1 Einlegeboden, B × H × T: 600 × 576 × 461 mm
Bathroom base unit, 1 door, 1 shelf, w × h × d: 600 × 576 × 461 mm

1 × ADB25 59 Abdeckboden, 25 mm stark, B × T: 1504 × 487 mm
Top shelf, 25 mm thick, w × d: 1504 × 487 mm

1 × WB 25-120 Wand-Steckbord, 25 mm stark, B × T: 1200 × 255 mm
Plug-in wall shelf, 25 mm thick, w × d: 1200 × 255 mm

1 × SPLH 90 Spiegel mit horizontalem LED-Lichtfenster, H × T: 850 × 24 mm
Mirror with horizontal LED lights, h × d: 850 × 24 mm

1 × NV203 Nischenwandverkleidung, 16 mm stark, B × H: 1200 × 850 mm
Niche cladding, 16 mm thick, w × h: 1200 × 850 mm

GSET03

Seite 70-71
page 70-71

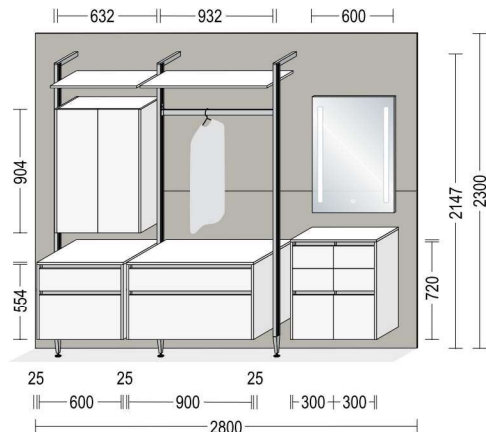

- 3 × HRS 30-02 Aluminiumstollen in Hochschrankhöhe 02, T: 295 mm**
Aluminium support poles in tall unit height 02, d: 295 mm
- 1 × NBUSA 60-55 Badezimmer-Auszugschrank, 1 Schubkasten, 1 Auszug, B × H × T: 600 × 554 × 461 mm**
Bathroom pull-out unit, 1 drawer, 1 pull-out, w × h × d: 600 × 554 × 461 mm
- 1 × ADB16 59 Abdeckboden, 16 mm stark, B × T: 632 × 484 mm**
Top shelf, 16 mm thick, w × d: 632 × 484 mm
- 1 × NBUSA 90-55 Badezimmer-Auszugschrank, 1 Schubkasten, 1 Auszug, B × H × T: 900 × 554 × 461 mm**
Bathroom pull-out unit, 1 drawer, 1 pull-out, w × h × d: 900 × 554 × 461 mm
- 1 × ADB16 59 Abdeckboden, 16 mm stark, B × T: 932 × 484 mm**
Top shelf, 16 mm thick, w × d: 932 × 484 mm
- 4 × NBUW 16-55 Abschlusswangen, 16 mm stark, H × T: 554 × 482 mm**
Upright at end of runs, 16 mm thick, h × d: 554 × 482 mm
- 1 × NW2T 60-03 Wandschrank, 2 Türen, 2 Einlegeböden, B × H × T: 600 × 904 × 320 mm**
Wall unit, 2 doors, 2 shelves, w × h × d: 600 × 904 × 320 mm
- 2 × WW 16-03 Abschluss-/Zwischenwange, 16 mm stark, H × T: 904 × 344 mm**
Upright at end of run/intermediate upright, 16 mm thick, h × d: 904 × 344 mm
- 1 × RSB16 60-38 Regalboden, 16 mm stark, B × T: Sondermaß 632 × Sondermaß 359 mm**
Shelf, 16 mm thick, B × T: special size 632 × special size 359 mm

- 1 × RSKST 93 Kleiderstange, B: 932 mm**
Clothes rail, w: 932 mm
- 1 × RSB16 90-38 Regalboden, 16 mm stark, B × T: Sondermaß 932 × Sondermaß 359 mm**
Shelf, 16 mm thick, w × d: special size 932 × special size 359 mm
- 2 × NBS2SA 30-72 Badezimmer-Sideboard, 2 Schubkästen, 1 Auszug, B × H × T: 300 × 720 × 320 mm**
Bathroom sideboard, 2 drawers, 1 pull-out, w × h × d: 300 × 720 × 320 mm
- 1 × ADB16 35 Abdeckboden, 16 mm stark, B × T: 636 × 343 mm**
Top shelf, 16 mm thick, w × d: 636 × 343 mm
- 2 × NBSW 16-72 LINE N-Abschlusswange, 16 mm stark, H × T: 720 × 341 mm**
LINE N upright at end of run, 16 mm thick, h × d: 720 × 341 mm
- 1 × SPLV 60 Spiegel mit vertikalen LED-Lichtfenstern, H × T: 850 × 24 mm**
Mirror with vertical LED light windows, h × d: 850 × 24 mm
- 2 × NVM120 Nischenverkleidung mit Motiv im Digitalprint, 16 mm stark, B × H: 2800 × 1150 mm**
Niche cladding with digitally printed motif, 16 mm thick, w × h: 2800 × 1150 mm
- 3 × RSSK Schrank-Konnektor**
Unit connector

SPEZIFIKATIONEN SPECIFICATIONS

Die Planungsvorschläge enthalten keine Leuchten oder Griffleisten-Mehrpriese. Diese müssen zusätzlich zur Set-Artikelnummer bestellt werden. Sondermaße gegen Mehrpreis. TV-Geräte und Dekorationsartikel sind nicht enthalten.

The planning suggestions do not include lights or surcharges for handles. These must be ordered in addition to the set item number. Special dimensions for a surcharge. TVs and decorative items are not included.

Kleidertraum Clothing dreams

DRSET01

Seite 72-75
page 72-75

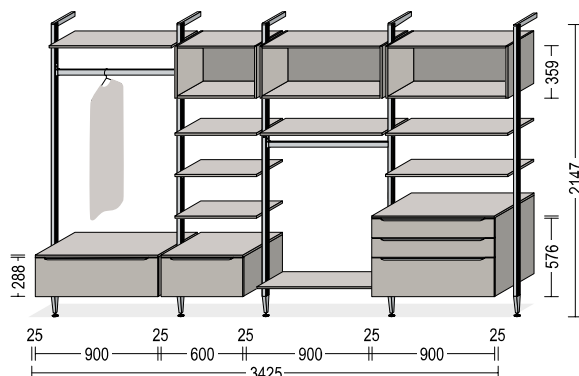

- | | | | |
|-----------------|-----------------------------------------------------------------------------------------------------------------------------------------------|-----------------|-------------------------------------------------------------------------------------------------------------------------------------------------------------------------|
| 5 × HRS 30-02 | Aluminiumstollen in Hochschrankhöhe 02, T: 295 mm
Aluminium support poles in tall unit height 02, d: 295 mm | 3 × RSB16 60-38 | Regalboden, 16 mm stark, B × T: 600 × 380 mm
Shelf, 16 mm thick, w × d: 600 × 380 mm |
| 1 × BUA 90-29 | Badezimmer-Auszugschrank, 1 Auszug, B × H × T: 900 × 288 × 461 mm
Bathroom pull-out unit, 1 pull-out, w × h × d: 900 × 288 × 461 mm | 1 × WR 60-36 | Wandregal, B × H × T: 600 × 359 × 335 mm
Open shelf wall unit, w × h × d: 600 × 359 × 335 mm |
| 2 × ADB16 59 | Abdeckboden, 16 mm stark, B × T: 900 × 487 mm
Top shelf, 16 mm thick, w × d: 900 × 487 mm | 2 × WR 90-36 | Wandregal, B × H × T: 900 × 359 × 335 mm
Open shelf wall unit, w × h × d: 900 × 359 × 335 mm |
| 2 × RSKST 90 | Kleiderstange, B: 900 mm
Clothes rail, w: 900 mm | 1 × BU2SA 90-58 | Badezimmer-Auszugschrank, 2 Schubkästen, 1 Auszug, B × H × T: 900 × 576 × 461 mm
Bathroom pull-out unit, 2 drawers, 1 pull-out, w × h × d: 900 × 576 × 461 mm |
| 5 × RSB16 90-38 | Regalboden, 16 mm stark, B × T: 900 × 380 mm
Shelf, 16 mm thick, w × d: 900 × 380 mm | 6 × RSSK | Schrank-Konnektor
Unit connector |
| 1 × BUA 60-29 | Badezimmer-Auszugschrank, 1 Auszug, B × H × T: 600 × 288 × 461 mm
Bathroom pull-out unit, 1 pull-out, w × h × d: 600 × 288 × 461 mm | | |
| 1 × ADB16 59 | Abdeckboden, 16 mm stark, B × T: 600 × 487 mm
Top shelf, 16 mm thick, w × d: 600 × 487 mm | | |

Kleidertraum Clothing dreams

DRSET02

Seite 76-77
page 76-77

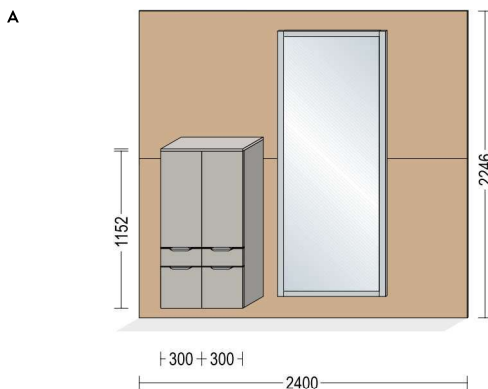
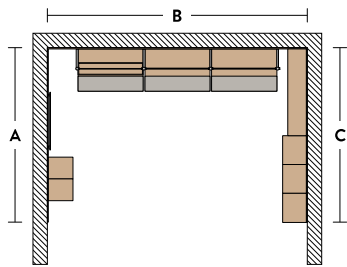

- 1 × NV203 **Nischenwandverkleidung, 16 mm stark, B × H: 2400 × 1192 mm**
Niche cladding, 16 mm thick, w × h: 2400 × 1192 mm
- 1 × NV203 **Nischenwandverkleidung, 16 mm stark, B × H: 2400 × 1054 mm**
Niche cladding, 16 mm thick, w × h: 2400 × 1054 mm
- 2 × BMSA 30-115 **Badezimmer-Midischrank, 1 Tür, 1 Schubkasten, 1 Auszug, 2 Einlegeböden, B × H × T: 300 × 1152 × 320 mm**
Bathroom Midi unit, 1 door, 1 drawer, 1 pull-out, 2 shelves, w × h × d: 300 × 1152 × 320 mm
- 1 × ADB16 35 **Abdeckboden, 16 mm stark, B × T: 604 × 346 mm**
Top shelf, 16 mm thick, w × d: 604 × 346 mm

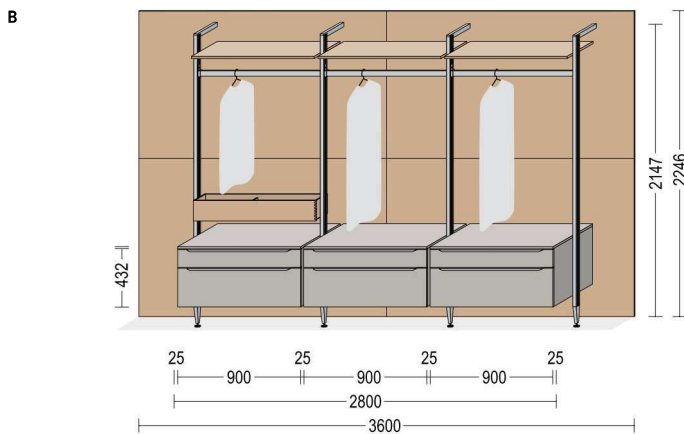

- 2 × NV203 **Nischenwandverkleidung, 16 mm stark, B × H: 1800 × 1054 mm**
Niche cladding, 16 mm thick, w × h: 1800 × 1054 mm
- 2 × NV203 **Nischenwandverkleidung, 16 mm stark, B × H: 1800 × 1192 mm**
Niche cladding, 16 mm thick, w × h: 1800 × 1192 mm
- 4 × HRS 30-02 **Aluminiumstollen in Hochschrankhöhe 02, T: 295 mm**
Aluminium support poles in tall unit height 02, d: 295 mm
- 3 × USARS 90-43 **Auszugschrank, 1 Schubkasten, 1 Auszug, B × H: 900 × 432 mm**
Pull-out unit, 1 drawer, 1 pull-out, w × h: 900 × 432 mm
- 3 × ADB16 59 **Abdeckboden, 16 mm stark, B × T: 900 × 587 mm**
Top shelf, 16 mm thick, w × d: 900 × 587 mm
- 3 × RSKST 90 **Kleiderstange, B: 900 mm**
Clothes rail, w: 900 mm
- 1 × RSHK 90-H **Holzkasten, B × H × T: 900 × 150 × 170 mm**
Wooden box, w × h × d: 900 × 150 × 170 mm
- 3 × RSB16 90-38 **Regalboden, 16 mm stark, B × T: 900 × 380 mm**
Shelf, 16 mm thick, w × d: 900 × 380 mm

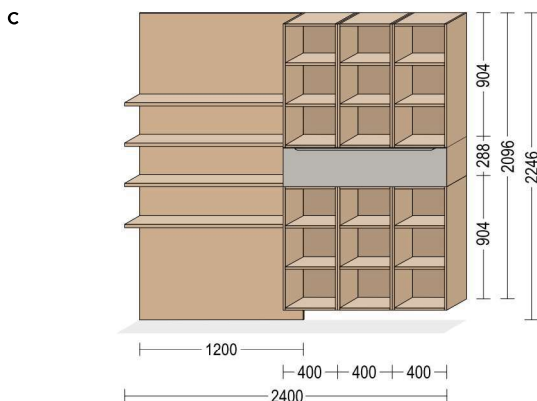

- 1 × NV203 **Nischenwandverkleidung, 16 mm stark, B × H: 1200 × 1054 mm**
Niche cladding, 16 mm thick, w × h: 1200 × 1054 mm
- 1 × NV203 **Nischenwandverkleidung, 16 mm stark, B × H: 1200 × 1192 mm**
Niche cladding, 16 mm thick, w × h: 1200 × 1192 mm
- 4 × WB25 120 **Wand-Steckbord, 25 mm stark, B × T: 1200 × 255 mm**
Plug-in wall shelf, 25 mm thick, w × d: 1200 × 255 mm
- 6 × WR 40-03 **Wandregal 2 feste Böden, B × H × T: 400 × 904 × 335 mm**
Open shelf wall unit with 2 fixed shelves, w × h × d: 400 × 904 × 335 mm
- 1 × BUA 120-29 **Badezimmer-Auszugschrank, 1 Auszug, B × H × T: 1200 × 288 × Sondermaß 320 mm**
Bathroom pull-out unit, 1 pull-out, w × h × d: 1200 × 288 × special size 320 mm

ALLES AUS EINER HAND

EVERYTHING FROM A SINGLE SOURCE

Vom Wohnzimmer über den Speiseraum bis hin zu Küche und Bad: Das flexible System und die große Auswahl an Fronten und Oberflächen machen es möglich, das Zuhause in einem Stil oder jeden Raum ganz unterschiedlich zu kreieren.

From the living room and dining room to the kitchen and bathroom: the flexible system and large selection of fronts and surfaces make it possible to decorate your home in a single style or design each room differently.



FRONTEN FRONTS

Fronten, die mit dem LINE N-Logo versehen sind, sind auch als grifflose Planungen lieferbar.
Fronts marked with the LINE N logo are also available as handleless designs.



SPEED 244 PG 1
Alpinweiß

SPEED 244 PG 1
Alpine white



SPEED 239 PG 1
Weiß softmatt

SPEED 239 PG 1
White softmatt



SPEED 206 PG 1
Magnolia softmatt

SPEED 206 PG 1
Ivory softmatt



SPEED 259 PG 1
Seidengrau

SPEED 259 PG 1
Satin grey



SPEED 288 PG 1
**Schwarzbeton
Nachbildung**

SPEED 288 PG 1
Black Concrete
reproduction



SPEED 262 PG 1
**Eiche Virginia
Nachbildung**

SPEED 262 PG 1
Virginia oak
reproduction



LASER 427 PG 2
Alpinweiß

LASER 427 PG 2
Alpine white



LASER 416 PG 2
Weiß

LASER 416 PG 2
White



LASER 418 PG 2
Magnolia matt

LASER 418 PG 2
Ivory matt



LASER 417 PG 2
Seidengrau

LASER 417 PG 2
Satin grey



LASER 415 PG 2
Sand

LASER 415 PG 2
Sand



RIO 666 PG 2
**Eiche Virginia
Nachbildung**

RIO 666 PG 2
Virginia oak
reproduction

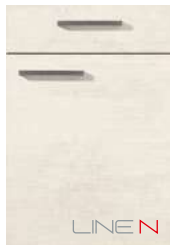

RIVA 891 PG 2
**Weißbeton
Nachbildung**

RIVA 891 PG 2
White Concrete
reproduction

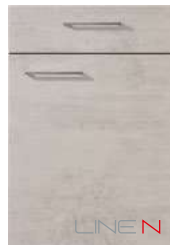

RIVA 892 PG 2
**Beton grau
Nachbildung**

RIVA 892 PG 2
Concrete grey
reproduction



RIVA 889 PG 2
**Beton schiefergrau
Nachbildung**

RIVA 889 PG 2
Concrete Slate Grey
reproduction



RIVA 893 PG 2
**Eiche San Remo
Nachbildung**

RIVA 893 PG 2
Sanremo oak
reproduction



RIVA 887 PG 2
**Eiche Somerset
Nachbildung**

RIVA 887 PG 2
Somerset oak
reproduction



STRUCTURA 401 PG 3
**Eiche Halifax
Nachbildung**

STRUCTURA 401 PG 3
Sherwood oak
reproduction



STRUCTURA 402 PG 3
**Eiche Havana
Nachbildung**

STRUCTURA 402 PG 3
Havana oak
reproduction



STRUCTURA 405 PG 3
**Eiche Sierra
Nachbildung**

STRUCTURA 405 PG 3
Sierra oak
reproduction



STRUCTURA 403 PG 3
**Eiche Nero
Nachbildung**

STRUCTURA 403 PG 3
Nero oak
reproduction



TOUCH 332 PG 3
**Lacklaminat,
Alpinweiß supermatt**

TOUCH 332 PG 3
Lacquered laminate,
alpine white supermatt



TOUCH 336 PG 3
**Lacklaminat,
Magnolia supermatt**

TOUCH 336 PG 3
Lacquered laminate,
ivory supermatt



TOUCH 338 PG 3
**Lacklaminat,
Seidengrau supermatt**

TOUCH 338 PG 3
Lacquered laminate,
satin grey supermatt

FRONTEN FRONTS

Fronten, die mit dem LINE N-Logo versehen sind, sind auch als grifflose Planungen lieferbar.
Fronts marked with the LINE N logo are also available as handleless designs.



TOUCH 341 PG 3
Lacklaminat,
Steingrau supermatt

TOUCH 341 PG 3
Lacquered laminate,
stone grey supermatt



TOUCH 337 PG 3
Lacklaminat,
Aqua supermatt

TOUCH 337 PG 3
Lacquered laminate,
aqua supermatt



TOUCH 334 PG 3
Lacklaminat,
Schiefergrau supermatt

TOUCH 334 PG 3
Lacquered laminate,
slate grey supermatt



TOUCH 340 PG 3
Lacklaminat,
Schwarz supermatt

TOUCH 340 PG 3
Lacquered laminate,
black supermatt



FLASH 503 PG 3
Lacklaminat,
Alpinweiß Hochglanz

FLASH 503 PG 3
Lacquered laminate,
alpine white high gloss



FLASH 450 PG 3
Lacklaminat,
Weiß Hochglanz

FLASH 450 PG 3
Lacquered laminate,
white high gloss

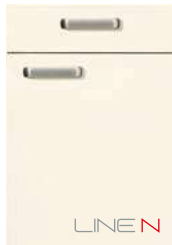

FLASH 452 PG 3
Lacklaminat,
Magnolia Hochglanz

FLASH 452 PG 3
Lacquered laminate,
ivory high gloss



FLASH 455 PG 3
Lacklaminat,
Seidengrau Hochglanz

FLASH 455 PG 3
Lacquered laminate,
satin grey high gloss



FLASH 453 PG 3
Lacklaminat,
Schiefergrau Hochglanz

FLASH 453 PG 3
Lacquered laminate,
slate grey high gloss



EASYTOUCH 961 PG 4
Lacklaminat,
Grafit schwarz ultramatt

EASYTOUCH 961 PG 4
Lacquered laminate,
graphite black ultra matt



EASYTOUCH 963 PG 4
Lacklaminat,
Rostrot ultramatt

EASYTOUCH 963 PG 4
Lacquered laminate,
rust red ultra matt



STONEART 304 PG 4
Schiefer steingrau
Nachbildung

STONEART 304 PG 4
Stone grey slate
reproduction



STONEART 303 PG 4
Grauschiefer
Nachbildung

STONEART 303 PG 4
Grey slate
reproduction



INOX 216 PG 4
Lacklaminat, Stahl
gebürstet Nachbildung

INOX 216 PG 4
Lacquered laminate,
brushed steel
reproduction



FASHION 168 PG 4
Lack,
Alpinweiß matt

FASHION 168 PG 4
Lacquer,
honed alpine white



FASHION 173 PG 4
Lack,
Weiß matt

FASHION 173 PG 4
Lacquer,
honed white



FASHION 175 PG 4
Lack,
Magnolia matt

FASHION 175 PG 4
Lacquer,
honed ivory



FASHION 171 PG 4
Lack,
Seidengrau matt

FASHION 171 PG 4
Lacquer,
honed satin grey



FASHION 165 PG 4
Lack,
Steingrau matt

FASHION 165 PG 4
Lacquer,
honed stone grey



FOCUS 470 PG 4
Lack, Alpinweiß
Ultra-Hochglanz

FOCUS 470 PG 4
Lacquer, alpine white
ultra high gloss



FOCUS 460 PG 4
Lack,
Weiß Ultra-Hochglanz

FOCUS 460 PG 4
Lacquer,
white ultra high gloss



FOCUS 462 PG 4
Lack, Magnolia
Ultra-Hochglanz

FOCUS 462 PG 4
Lacquer,
ivory ultra high gloss



FOCUS 467 PG 4
Lack,
Sand Ultra-Hochglanz

FOCUS 467 PG 4
Lacquer,
sand ultra high gloss



INLINE 551 PG 5
Lack,
Alpinweiß matt

INLINE 551 PG 5
Lacquer,
honed alpine white



GENT 741 PG 5
Lacklaminat, Steingrau

GENT 741 PG 5
Lacquered laminate, stone grey



CREDO 764 PG 6
Lacklaminat, Alpinweiß

CREDO 764 PG 6
Lacquered laminate, alpine white



CREDO 765 PG 6
Lacklaminat, Schiefergrau

CREDO 765 PG 6
Lacquered laminate, slate grey



KANSAS 597 PG 7
Eiche Sierra Nachbildung

KANSAS 597 PG 7
Sierra oak reproduction



CASCADA 774 PG 7
Lacklaminat, Weiß

CASCADA 774 PG 7
Lacquered laminate, white



CASCADA 772 PG 7
Lacklaminat, Steingrau

CASCADA 772 PG 7
Lacquered laminate, stone grey



CASCADA 776 PG 7
Lacklaminat, Schilf

CASCADA 776 PG 7
Lacquered laminate, reed green



SYLT 847 PG 7
Lack, Alpinweiß matt

SYLT 847 PG 7
Lacquer, honed alpine white



SYLT 849 PG 7
Lack, Magnolia matt

SYLT 849 PG 7
Lacquer, honed ivory



SYLT 851 PG 7
Lack, Schwarz matt

SYLT 851 PG 7
Lacquer, honed black



CASTELLO 390 PG 8
Magnolia gewischt

CASTELLO 390 PG 8
Washed ivory



CEMENTO 803 PG 8
Lack, Zementgrau

CEMENTO 803 PG 8
Lacquer, cement grey



LUX 817 PG 9
Lack, Alpinweiß Hochglanz

LUX 817 PG 9
Lacquer, alpine white high gloss



LUX 814 PG 9
Lack, Weiß Hochglanz

LUX 814 PG 9
Lacquer, white high gloss



LUX 816 PG 9
Lack, Magnolia Hochglanz

LUX 816 PG 9
Lacquer, ivory high gloss



LUX 819 PG 9
Lack, Seidengrau Hochglanz

LUX 819 PG 9
Lacquer, satin grey high gloss



LUX 823 PG 9
Lack, Schiefergrau Hochglanz

LUX 823 PG 9
Lacquer, slate grey high gloss

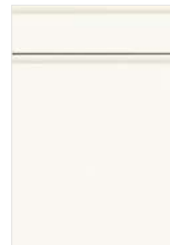

PURA 834 PG 9
Lack, Weiß Hochglanz

PURA 834 PG 9
Lacquer, white high gloss



CHALET 885 PG 9
Lack, Weiß matt

CHALET 885 PG 9
Lacquer, honed white



CHALET 883 PG 9
Lack, Magnolia matt

CHALET 883 PG 9
Lacquer, honed ivory



CHALET 881 PG 9
Lack, Sand matt

CHALET 881 PG 9
Lacquer, honed sand



YORK 905 PG 9
Echtholz, Magnolia lackiert

YORK 905 PG 9
Genuine wood, lacquered ivory



YORK 901 PG 9
Echtholz, Seidengrau lackiert

YORK 901 PG 9
Genuine wood, lacquered satin grey

ARBEITSPLETTEN WORKTOPS

98-99



066 Schiefer Nachbildung
066 Slate décor reproduction



070* Seidengrau
070* Satin grey



078 Eiche San Remo Nachbildung
078 Sanremo oak reproduction



089* Steingrau
089* Stone grey



097 Eiche Havanna Nachbildung
097 Havana oak reproduction



117 Copper Vintage Nachbildung
117 Vintage Copper décor



123 Eiche Virginia Nachbildung
123 Virginia oak reproduction



186 Schwarz
186 Black



192 Eiche Provence Nachbildung
192 Oak Provence reproduction



193* Alpenweiß
193* Alpine white



194* Schiefergrau
194* Slate grey



196 Eiche Ontario Nachbildung
196 Ontario oak reproduction



198 Eiche Sierra Nachbildung
198 Sierra oak reproduction



204 Ponderosa Pine Nachbildung
204 Ponderosa pine reproduction



215 Stromboli hell Nachbildung
215 Strombolian light reproduction



220 Arizona Pine Nachbildung
220 Arizona pine reproduction



225 Stammeiche Nachbildung
225 Stem oak reproduction



226 Dekor Metal Art Nachbildung
226 Metal art décor



265 Rusty Plates Nachbildung
265 Rusty plates reproduction



266 Caledonia
266 Caledonia



272 Balkeneiche Nachbildung
272 Timber oak reproduction



273 Carrara Nachbildung
273 Carrara marble reproduction



274 Marmor Teramo Nachbildung
274 Teramo marble reproduction



316 Maracaibo hell Nachbildung
316 Maracaibo light décor



319 Dekor Oxid
319 Oxid décor



330* Beton grau Nachbildung
330* Concrete grey reproduction



344* Granit schwarz geflammt Nachbildung
344* Black granite décor



345 Eiche Yukon Nachbildung
345 Yukon oak reproduction



347 Taxus Nachbildung
347 Taxus reproduction



352 Eiche Halifax Nachbildung
352 Sherwood oak reproduction



353* Weißbeton Nachbildung
353* White Concrete reproduction



354* Beton schiefergrau Nachbildung
354* Concrete Slate Grey reproduction



355* Ferro Bronze Nachbildung
355* Ferro bronze décor



356 Endgrain Oak Nachbildung
356 Endgrain oak reproduction



376* Limestone Nachbildung
376* Limestone reproduction



377 Eiche geölt Nachbildung
377 Oiled oak reproduction



378 Schwarzbeton Nachbildung
378 Black Concrete reproduction



379 Eiche Somerset Nachbildung
379 Somerset oak reproduction



393 Vintage Oak Nachbildung
393 Vintage oak reproduction



394 Travertin sandbeige Nachbildung
394 Champagne travertine reproduction



395 Verso Nachbildung
395 Verso reproduction



396 Terrazzo grau Nachbildung
396 Grey terrazzo reproduction



Arbeitsplatte APN mit N-Kante

Worktop APN with N edge



Arbeitsplatte APD mit Dekorkante

Worktop APD with décor edge

XTRA



369* Schiefer steingrau Nachbildung
369* Stone grey slate reproduction



373* Grauschiefer Nachbildung
373* Grey slate reproduction



367* Eiche Artisan Nachbildung
367* Artisan oak reproduction



368 Mixwood Nachbildung
368 Mixedwood reproduction



Eine Ansicht der kompletten Dekorlänge finden Sie auf www.nobilite.de
A view of the entire length of the décor can be found at www.nobilite.de

* Auch als Slim Line-Arbeitsplatte, 16 mm stark, lieferbar.
* Also available as Slim Line worktop, 16 mm thick.

KORPUSDEKORE CARCASE DÉCORS

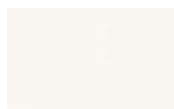

193 Alpinweiß

193 Alpine white

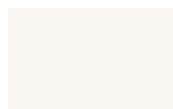

060 Alpinweiß Glanz

060 Alpine white gloss

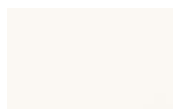

106 Weiß

106 White

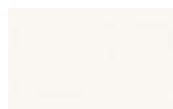

022 Weiß Glanz

022 White gloss

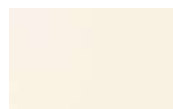

120 Magnolia matt

120 Ivory matt

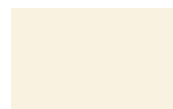

116 Magnolia Glanz

116 Ivory gloss



070 Seidengrau

070 Satin grey



089 Steingrau

089 Stone grey

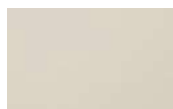

122 Sand

122 Sand



194 Schiefergrau

194 Slate grey



**123 Eiche Virginia
Nachbildung**

123 Virginia oak
reproduction



**078 Eiche San Remo
Nachbildung**

078 Sanremo oak
reproduction



**198 Eiche Sierra
Nachbildung**

198 Sierra oak
reproduction



**097 Eiche Havanna
Nachbildung**

097 Havana oak
reproduction

COLOR CONCEPT COLOR CONCEPT



241 Sonnengelb

241 Maize Yellow



248 Farn

248 Fern



254 Aqua

254 Aqua



257 Salbei

257 Sage



**265 Rusty Plates
Nachbildung**

265 Rusty plates
reproduction



266 Caledonia

266 Caledonia



**272 Balkeneiche
Nachbildung**

272 Timber oak
reproduction



**273 Carrara
Nachbildung**

273 Carrara marble
reproduction



**274 Marmor Teramo
Nachbildung**

274 Teramo marble
reproduction



**355 Ferro Bronze
Nachbildung**

355 Ferro bronze
décor

GRIFFAUSWAHL[™] HANDLE SELECTION[™]

Griffe edelstahlfarbig Handles in stainless steel finish



**013* Metallgriff
Edelstahlfarbig**

013* Metal handle
Stainless steel finish



**019* Metallgriff
Edelstahlfarbig**

019* Metal handle
Stainless steel finish



**042 Metallgriff
Edelstahlfarbig**

042 Metal handle
Stainless steel finish



**062 Metallgriff
Edelstahlfarbig**

062 Metal handle
Stainless steel finish



**067 Metallgriff
Edelstahlfarbig**

067 Metal handle
Stainless steel finish



**069 Metallgriff
Edelstahlfarbig**

069 Metal handle
Stainless steel finish



**077 Metallgriff
Edelstahlfarbig**

077 Metal handle
Stainless steel finish



**098 Metallgriff
Nickel matt**

098 Metal handle
Matt nickel



**183 Metallgriff
Edelstahlfarbig**

183 Metal handle
Stainless steel finish



**186 Metallgriff
Edelstahlfarbig**

186 Metal handle
Stainless steel finish



**218 Metallgriff
Edelstahlfarbig/
Chrom Glanz**

218 Metal handle
Stainless steel finish/
Brilliant chrome



**221 Metallgriff
Edelstahlfarbig**

221 Metal handle
Stainless steel finish



**237 Metallgriff
Edelstahlfarbig**

237 Metal handle
Stainless steel finish



**263 Metallgriff
Edelstahlfarbig**

263 Metal handle
Stainless steel finish



**279 Metallgriff
Edelstahlfarbig**

279 Metal handle
Stainless steel finish



**331 Metallgriff
Edelstahlfarbig**

331 Metal handle
Stainless steel finish



**508 Metallgriff
Edelstahlfarbig**

508 Metal handle
Stainless steel finish



**544 Metallgriff
Edelstahlfarbig**

544 Metal handle
Stainless steel finish



**549 Metallgriff
Edelstahlfarbig**

549 Metal handle
Stainless steel finish



**552 Metallgriff
Edelstahlfarbig**

552 Metal handle
Stainless steel finish



**602 Metallgriff
Edelstahlfarbig**

602 Metal handle
Stainless steel finish



**608 Metallgriff
Edelstahlfarbig**

608 Metal handle
Stainless steel finish



**708 Metallgriff
Edelstahlfarbig**

708 Metal handle
Stainless steel finish



**801 Metallgriff
Edelstahlfarbig**

801 Metal handle
Stainless steel finish

Griffe Anthrazit/Schwarz Handles in Anthracite/Black



**563 Metallgriff
Schwarz/Edelstahl-
farbig**

563 Metal handle
Black/Stainless steel
finish



**570 Metallgriff
Schwarz**

570 Metal handle
Black



**595 Metallgriff
Schwarz/Edelstahl-
farbig**

595 Metal handle
Black/Stainless steel
finish



**616 Gusseisengriff
Schwarz**

616 Cast iron handle
Black



**707 Metallgriff
Anthrazit gebürstet**

707 Metal handle
Brushed anthracite

Knöpfe Knobs



**610 Gusseisenknopf
Schwarz**

610 Cast iron knob
Black



**677 Metallknopf
Edelstahlfarbig**

677 Metal knob
Stainless steel finish



**678 Metallknopf
Edelstahlfarbig**

678 Metal knob
Stainless steel finish



**679 Metallknopf
Schwarz**

679 Metal knob
Black

«Unser gesamtes Angebotsspektrum von Griffen entnehmen Sie bitte unserem Verkaufshandbuch.
«Please refer to our sales manual for our complete range of handles.

*Dieser Griff ist mehrpreispflichtig.
*This handle requires a surcharge.

Griffe mit Effektveredelung Handles with effect finishing



056 Metallgriff
Used look

056 Metal handle
Used look



088 Metallgriff
Anthrazit gebürstet

088 Metal handle
Brushed anthracite



099 Metallgriff
Industrial Style

099 Metal handle
Industrial Style



119 Metallgriff
Altsilberfarbig

119 Metal handle
Antique silver colour



190* Bügelgriff
Chrom Glanz

190* Bow handle
Brilliant chrome



192 Metallgriff
Chrom Glanz

192 Metal handle
Brilliant chrome



271 Metallgriff
Titanfarbig

271 Metal handle
Titanium-coloured



280 Metallgriff
Alteisenfarbig

280 Metal handle
Antique iron colour



284 Metallgriff
Altsilberfarbig

284 Metal handle
Antique silver colour



358 Metallgriff
Titanfarbig

358 Metal handle
Titanium-coloured



509 Metallgriff
Grau

509 Metal handle
grey



556 Metallgriff
Altsilberfarbig

556 Metal handle
Antique silver colour



733 Metallgriff
Schwarzchrom

733 Metal handle
Chromed black



737 Holz-Metallgriff
Eiche/Schwarz

737 Wood/Metal
handle Oak/Black



739* Metallgriff
Schwarz

739* Metal handle
black



799 Metallgriff
Schwarzchrom

799 Metal handle
Chromed black

Griffleisten Bar handles



240* Griffleiste
Schwarz

240* Bar handle
Black



300* Griffleiste
Edelstahlfarbig

300* Bar handle
Stainless steel finish



350* Griffleiste
Edelstahlfarbig

350* Bar handle
Stainless steel finish



430* Griffleiste
Edelstahlfarbig

430* Bar handle
Stainless steel finish



550* Griffleiste
Edelstahlfarbig

550* Bar handle
Stainless steel finish



600* Griffleiste
Schwarz

600* Bar handle
Black



690* Griffleiste
Alpinweiß

690* Bar handle
Alpine white



710* Griffleiste
Steingrau

710* Bar handle
Stone grey



730* Griffleiste
Schiefergrau

730* Bar handle
Slate grey



760* Griffleiste
Edelstahlfarbig

760* Bar handle
Stainless steel finish



870* Griffleiste
Schwarz

870* Bar handle
Black

Relingstangen Railing handles



370* Relingstange
Edelstahlfarbig

370* Railing handle
Stainless steel finish



620* Relingstange
Schwarz

620* Railing handle
Black



650* Relingstange
Edelstahlfarbig

650* Railing handle
Stainless steel finish



900* Relingstange
Edelstahlfarbig

900* Railing handle
Stainless steel finish



930* Relingstange
Edelstahlfarbig

930* Railing handle
Stainless steel finish

***Dieser Griff ist mehrpreispflichtig.**
*This handle requires a surcharge.

Technische Änderungen, Liefermöglichkeiten, Irrtümer und drucktechnisch bedingte Farbabweichungen vorbehalten. Alle Einrichtungsbeispiele sind unverbindlich. All rights to technical alterations, delivery possibilities, errors and printing-related colour deviations are reserved. All furnishing examples are non-binding.



Qualität made in Germany

Quality made in Germany

Ausgesuchte Materialien, exzellente Verarbeitung, Perfektion bis ins Detail: Unsere Möbel werden nach höchsten Qualitätskriterien entwickelt und gefertigt. Dabei produzieren wir ausschließlich am Standort Deutschland.

Bevor unsere Produkte in Serie gehen, werden alle eingesetzten Materialien in umfangreichen Testverfahren im Labor auf eine Mindestlebensdauer von 15 Jahren geprüft und durch internationale, unabhängige Institute kontrolliert und zertifiziert. Denn die Zufriedenheit unserer Kunden ist für uns der höchste Maßstab.

Selected materials, excellent workmanship, perfection right down to the finest detail: our furniture is developed and manufactured according to the highest of quality standards. Our products are made exclusively in Germany.

Before our products go into series production, all the materials used are subjected to extensive test procedures in the laboratory for a minimum service life of 15 years and inspected and certified by independent international institutes. After all, our customers' satisfaction is our benchmark.







Keo

www.keo.no | post@keo.no